



Customer Order Number: DOC-784195=
Documentation Part Number: 78-4195-04

Regulatory Compliance and Safety Information for the Cisco 7000 Series Routers

Product Numbers: CISCO7000(=), CISCO7010(=)

Introduction

This publication provides international agency compliance, safety, and statutory information for fiber optic and wide area network (WAN) interfaces for the Cisco 7000 series routers, which include the Cisco 7000 and the Cisco 7010. Also provided are translations for the safety warnings in the *Hardware Installation and Maintenance* and *User Guide* publications that shipped with your Cisco 7000 series router and the field-replaceable units (FRUs) that can be used in Cisco 7000 series routers.

Contents

The following sections are included in this publication:

- If You Need More Information, page 2
- Cisco 7000 Series Overview, page 3
- Agency Approvals for the Cisco 7000 Series Routers, page 6
- Safety Information, page 7
- Installation Requirements, page 9
- FSIP with E1-G.703/G.704 Port Adapter, page 10
- FSIP with Five-in-One Port Adapter, page 11
- MIP Port Adapter with PRI, page 13
- Channelized T3 Interface Processor (CT3IP), page 15

Corporate Headquarters

Cisco Systems, Inc.
170 West Tasman Drive
San Jose, CA 95134-1706
USA

Copyright © 1993–1999
Cisco Systems, Inc.
All rights reserved.

- VIP2-Based Port Adapters, page 17
- Translated Safety Warnings, page 40
- Cisco Connection Online, page 63
- Documentation CD-ROM, page 64

If You Need More Information

Your router and the Cisco IOS software running on it contain extensive features and functionality, which are documented in the following resources:

- Cisco Documentation CD-ROM package

Cisco documentation and additional literature are available in a CD-ROM package, which ships with your product. The Documentation CD-ROM, a member of the Cisco Connection Family, is updated monthly. Therefore, it might be more current than printed documentation. To order additional copies of the Documentation CD-ROM, contact your local sales representative or call customer service. The CD-ROM package is available as a single package or as an annual subscription. You can also access Cisco documentation on the World Wide Web at <http://www.cisco.com>, <http://www-china.cisco.com>, or <http://www-europe.cisco.com>.

If you are reading Cisco product documentation on the World Wide Web, you can submit comments electronically. Click **Feedback** in the toolbar and select **Documentation**. After you complete the form, click **Submit** to send it to Cisco. We appreciate your comments.

- For Cisco IOS software configuration information and support, refer to the modular configuration and modular command reference publications in the Cisco IOS software configuration documentation set that corresponds to the software release installed on your Cisco hardware.
- For hardware installation and maintenance information on the Cisco 7000 series routers, refer to the *Cisco 7000 Hardware Installation and Maintenance* manual and the *Cisco 7000 User Guide*, or to the *Cisco 7010 Hardware Installation and Maintenance* manual and the *Cisco 7010 User Guide*, which shipped with your Cisco 7000 or Cisco 7010 router, respectively.

Note You can access Cisco IOS software documentation and hardware installation and maintenance documentation on the World Wide Web at <http://www.cisco.com>, <http://www-china.cisco.com>, <http://www-europe.cisco.com>.

- To view Cisco documentation or obtain general information about documentation, refer to the following sources:
 - Documentation CD-ROM.
 - Cisco Connection Online (CCO). (See the “Cisco Connection Online” section on page 63.)
 - Customer Service at 800 553-6387 or 408 526-7208. Customer Service hours are 5:00 a.m. to 6:00 p.m. Pacific time, Monday through Friday (excluding company holidays). You can also send e-mail to cs-rep@cisco.com.
 - The *Cisco Information Packet* that shipped with your router.

Cisco 7000 Series Overview

This section provides an overview of the Cisco 7000 series routers: Cisco 7000 and Cisco 7010.

Cisco 7000 Series Power Supply Power Ratings

Table 1 lists AC-input and DC-input power ratings for the Cisco 7000 series routers.

Table 1 AC-Input and DC-Input Power Ratings

Router Models	AC-Input Ratings	DC-Input ratings
Cisco 7000	100 to 240 VAC, 12 to 6A, 50/60 Hz	-48 to -72 VDC, 24 to 13A
Cisco 7010	100 to 240 VAC, 9 to 4A, 50/60 Hz	-48 to -60 VDC, 20/16A

The following sections provide descriptions of the Cisco 7000 series routers:

- Cisco 7000
- Cisco 7010, page 5

Cisco 7000

The Cisco 7000 is a 7-slot router chassis, which uses the Route Processor (RP) and CxBus and CyBus interface processors. Network interfaces reside on modular interface processors, which provide a direct connection between the high-speed, 533-megabits-per-second (Mbps) Cisco Extended Bus (CxBus) and external networks. Two of the slots are reserved for the Route Processor (RP), which contains the system processor, and the Switch Processor (SP) or Silicon Switch Processor (SSP), each of which performs packet-switching functions. The remaining five slots, numbered 0 to 4 from left to right, support any combination of network interfaces.

Note The Cisco 7000 can also be used with the optional 7000 Series Route Switch Processor (RSP7000) and 7000 Series Chassis Interface (RSP7000CI) (not shown), which replace the RP and SP (or SSP) combination, and provide the Cisco 7000 series routers with additional features and improved performance.

The Cisco 7000 is available with either one or two 700-watt (W) AC-input power supplies, or one or two 700W DC-input power supplies. The AC-input power supply operates on AC-input power, and the DC-input power supply operates on DC-input power; both supply DC power to the internal components.

Figure 1 Cisco 7000 (Interface Processor End)

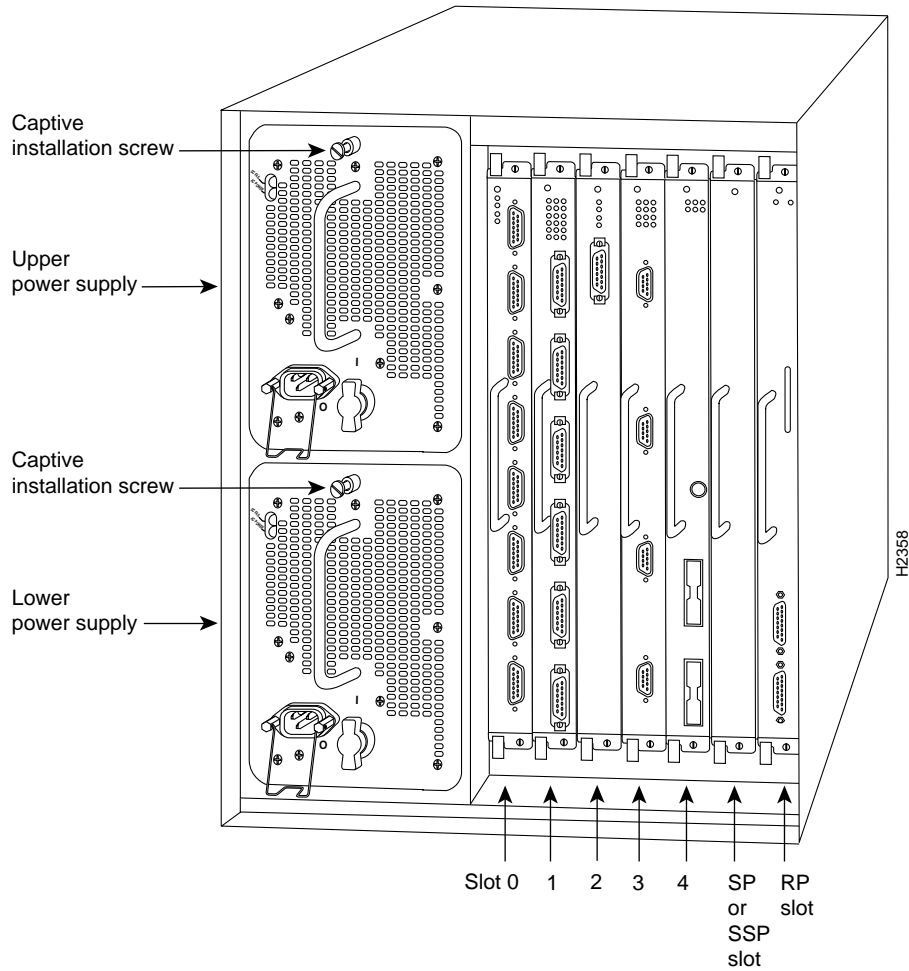

The system blower provides cooling air for the processor modules. The blower is located inside the front chassis compartment of the Cisco 7000. An internal fan in each power supply draws cooling air from the front of the chassis, through the power supply, and out the rear of the chassis. An air dam keeps the power-supply airflow separate from that of the rest of the chassis (which is cooled by the system blower).

Cisco 7010

The Cisco 7010 is a 5-slot router chassis, which uses the Route Processor (RP) and CxBus and CyBus interface processors. Network interfaces reside on modular interface processors, which provide a direct connection between the high-speed, 533-megabits-per-second (Mbps) Cisco Extended Bus (CxBus) and external networks.

Two of the slots are reserved for the RP, which contains the system processor, and the Switch Processor (SP) or Silicon Switch Processor (SSP), each of which performs packet-switching functions. The remaining three slots, numbered 0 to 2 from bottom to top, support any combination of network interfaces.

Note The Cisco 7010 can also be used with the optional 7000 Series Route Switch Processor (RSP7000) and 7000 Series Chassis Interface (RSP7000CI) (not shown), which replace the RP and SP (or SSP) combination, and provide the Cisco 7000 series routers with additional features and improved performance.

The Cisco 7010 comes equipped with one 600W, AC-input power supply or one 600W, DC-input power supply. The AC-input power supply operates on AC-input power and, the DC-input power supply operates on DC-input power; both supply DC power to the internal components.

Figure 2 Cisco 7010 (Interface Processor End)

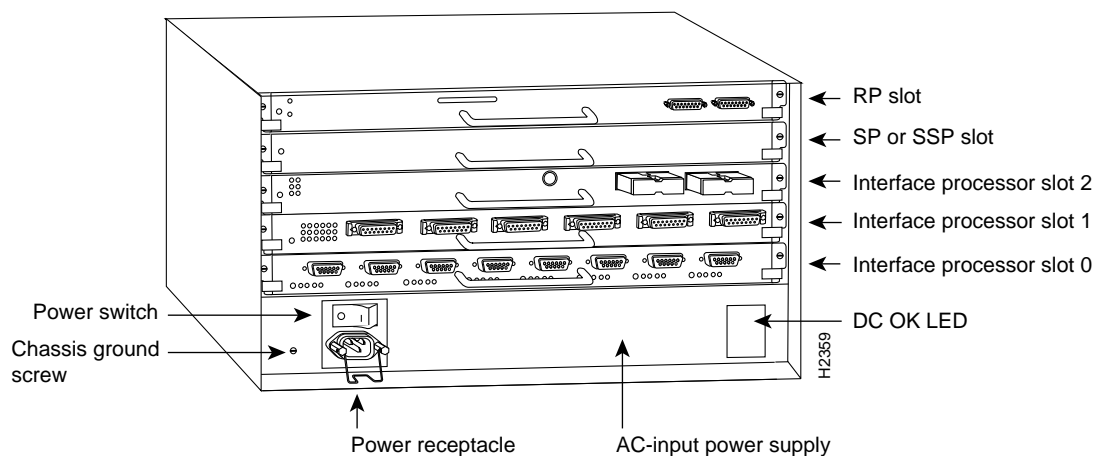

An array of six individual fans (called a *fan tray*) draw cooling air through the chassis interior to maintain an acceptable operating temperature for the internal components. The fan tray comprises the six fans and a printed circuit board (with the control circuits) mounted on a metal plate. The fan tray slides into the right side of the chassis from the noninterface processor end of the router. The fans draw air in through the inlet vents on the opposite side of the chassis, across the processor modules and other internal components, and out through the exhaust vents adjacent to the fan tray.

Agency Approvals for the Cisco 7000 Series Routers

Following are the agency approvals for the Cisco 7000 series:

- Versatile Interface Processor 2 (VIP2)-based port adapters:
 - Safety: UL 1950, CSA 22.2 No. 950, EN60950, AUSTEL TS001, AS/NZS 3260, IEC 950
 - EMI: FCC Class A, CSA, EN55022 Class B, VCCI Class 2, AS/NZS 3548 Class A
 - Immunity: IEC-1000-4-2, IEC-1000-4-3, IEC-1000-4-4, IEC-1000-4-5, IEC-1000-4-6, IEC-1000-4-11, IEC 1000-3-2
- Fast Serial Interface Processor (FSIP) with five-in-one adapter, EMI: FCC Class A, EN55022 Class B, VCCI Class 2
- FSIP with E1-G.703/G.704 adapter: EN55022 Class A
- MultiChannel Interface Processor (MIP) with E1: EN55022 Class B

Following is a current list of the European Union (EU) countries:

- Austria
- Belgium
- Denmark
- Finland
- France
- Germany
- Greece
- Ireland
- Italy
- Luxembourg
- The Netherlands
- Northern Ireland
- Portugal
- Spain
- Sweden
- United Kingdom

The CE marking on the chassis rear panel signifies that the Cisco 7000 and Cisco 7010 chassis meet the following European Directives: 73/23/EEC and 89/336/EEC. The marking is shown in Figure 3.

Figure 3 **CE Marking**



This marking is recognized by the EU countries listed above. The CE marking is also recognized by the following non-EU countries:

- Iceland
- Liechtenstein
- Norway
- Switzerland

Safety Information

Follow these guidelines to help ensure your safety and protect the equipment. This list does not cover all potentially hazardous situations, so *be alert*.

- Note that the installation of your equipment should be in compliance with national and local electrical codes. In the United States, National Fire Protection Association (NFPA) 70, United States National Electrical Code. In Canada, Canadian Electrical Code, part I, CC22.1. In other countries, International Electrotechnical Commission (IEC) 364, part 1 through part 7.
- Never attempt to lift an object that might be too heavy for you to lift by yourself.
- Always turn all power supplies off (O) and unplug all power cables before opening the chassis.
- Always unplug the power cable before installing or removing a chassis.
- Keep the chassis area clear and dust-free during and after installation.
- Keep tools and chassis components away from walk areas.
- Do not wear loose clothing, jewelry (including rings and chains), or other items that could get caught in the chassis. Fasten your tie or scarf and sleeves.
- All AC-input equipment ships with a three-wire electrical grounding-type plug, which only fits into a grounding-type power outlet. This is a safety feature. The equipment grounding should be in accordance with local and national electrical codes. The equipment operates safely when it is used in accordance with its marked electrical ratings and product usage instructions.
- For DC-input equipment, a DC circuit breaker is required for the DC-input power source. This circuit breaker should protect against short-circuit and overcurrent faults in accordance with United States National Electrical Code NFPA 70 (United States), Canadian Electrical Code, part I, C22.1 (Canada), and IEC 364 (other countries).
- For DC-input equipment, a readily accessible disconnect device must be incorporated in the fixed wiring.
- For DC-input Cisco 7000 series chassis, the unit is to be installed in a restricted access area in accordance with articles 110-16, 110-17, and 110-18 of the National Electric Code, ANSI/NFPA 70.
- The following operating conditions are required within the European Union: The ports marked “Ethernet,” “10BaseT,” “TokenRing,” “FDDI,” “Console,” and “AUX” are Safety Extra-low Voltage (SELV) circuits. SELV circuits should only be connected to other SELV circuits.

Follow these basic guidelines when working with any electrical equipment:

- Before beginning any procedures requiring access to the chassis interior, locate the emergency power-off switch for the room in which you are working.
- Disconnect all power and external cables before installing or removing a chassis.
- Do not work alone when potentially hazardous conditions exist.

- Never assume that power has been disconnected from a circuit; always check.
- Do not perform any action that creates a potential hazard to people or makes the equipment unsafe.
- Never install equipment that appears damaged.
- Carefully examine your work area for possible hazards such as moist floors, ungrounded power extension cables, and missing safety grounds.

In addition, use the guidelines that follow when working with any equipment that is disconnected from a power source but still connected to telephone wiring or other network cabling.

- Never install telephone wiring during a lightning storm.
- Never install telephone jacks in wet locations unless the jack is specifically designed for wet locations.
- Never touch uninsulated telephone wires or terminals unless the telephone line has been disconnected at the network interface.
- Use caution when installing or modifying telephone lines.

If you have any doubt about how to safely install a port adapter correctly in a Cisco 7000 series router, contact a qualified telecommunications engineer.

Following are safety instructions that you must observe when installing a Fast Serial Interface Processor (FSIP), a MultiChannel Interface Processor (MIP), or a second-generation Versatile Interface Processor (VIP2)-based port adapter in a Cisco 7000 series router:

- The port adapter might contain SELV circuitry. Ensure that attachments at the interconnection ports of the apparatus are also SELV circuits. (SELV circuits are so designed and protected that, under both normal conditions and a likely fault condition, the voltage that can be drawn is not hazardous.)
- Always disconnect the chassis from the power supply before removing any covers.
- Do not work on the system or connect and disconnect cables during a lightning storm.
- Always disconnect the host product chassis from any analog telephone circuits or ISDN (where applicable) before removing any covers.

Note The host chassis should always be connected to earth ground during normal use.

Failure to install the interface processors and port adapters in accordance with these instructions will invalidate the approval.

If you have any doubt about how to safely install a VIP2-based port adapter correctly in a Cisco 7000 series router, contact a qualified telecommunications engineer.

Installation Requirements

This section describes the general installation requirements for FSIP, MIP, and VIP2-based port adapters installed in Cisco 7000 series routers.

Where applicable, each FSIP, MIP, and VIP2-based port adapter is approved only for installation in a host and with host attachments, which are either **type approved** for such apparatus or covered by a **General Approval**. Except at the edge connector, which plugs into the router's midplane, clearance and creepage distances of X millimeters (mm) and Y mm, as listed in Table 2, must be maintained between the port adapter and other parts of the host, including any other port adapters.

Creepage distance is defined as the minimum distance between two points (following the contour of the insulator) measured across the surface of an insulator. Clearance distance is defined as the minimum distance between two points (line of sight) measured in air.

Table 2 Creepage and Clearance Distances Based on Voltage

Voltage Used or Generated by Other Parts of the Host or Expansion Card (Vrms ¹ or VDC ²)	Creepage (Y mm) ³	Clearance (X mm)
Up to 50	2.4 (3.8)	2.0
Up to 125	3.0 (4.8)	2.6
Up to 250	5.0 (8.0)	4.0
Up to 300 ⁴	6.4 (10.0)	4.0

1 Vrms = root mean square voltage.

2 VDC = volts direct current.

3 The creepage distances not in parentheses apply when the equipment is installed in a normal office environment. The larger dimensions, given in parentheses, must be applied when the equipment is installed in an environment in which dust and other types of pollution could conduct electricity because of the effects of dampness and condensation. This applies to locations subject to high humidity.

4 For working voltages exceeding 300V, consult a competent telecommunications engineer prior to installation.

Clearance and creepage distances are measured between adjacent parts, as shown in Figure 4.

Figure 4 Creepage and Clearance Distance Measurements

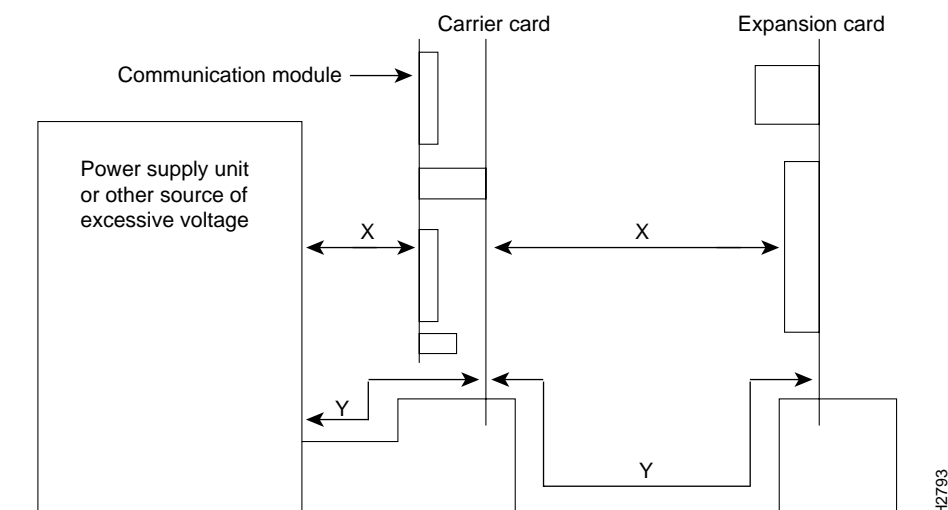

Note that in Figure 4, X indicates the clearance distances between the cards and between adjacent cards and components, and Y shows the creepage path across the surface of an insulator and between the two points indicated by X.

FSIP with E1-G.703/G.704 Port Adapter

The Fast Serial Interface Processor (FSIP) with E1-G.703/G.704 port adapter is a chassis-mounted processor and interface card for use within a range of data communication (gateway and router) chassis supplied by Cisco Systems. The FSIP with E1-G.703/G.704 is a self-contained product that provides all of the hardware and software necessary to allow connection of Cisco's chassis to digital leased-line circuits (point to point) using CCITT (ITU-T) recommendation G.703 operating protocols at speeds up to 2 Mbps. The FSIP with E1-G.703/G.704 is fully transportable between compatible *host* chassis. The choice of each compatible chassis has no effect on capabilities, functionality, or performance of the FSIP with E1-G.703/G.704.

The FSIP with E1-G.703/G.704 consists of the following subassemblies:

- FSIP
- E1-G.703/G.704 port adapter (unbalanced and balanced)

The FSIP with E1-G.703/G.704 accommodates up to four E1-G.703/G.704 adapter cards providing a maximum of eight serial port connections. Each port can provide connection to 2-Mbps leased lines. Combined, the FSIP and E1-G.703/G.704 adapter cards provide all of the hardware necessary for supporting leased-line communications.

Each port on the E1-G.703/G.704 port adapter has a 15-pin D-type connector. Each port is configured at the factory to offer either 75-ohm termination impedance for unbalanced operation or 120-ohm termination impedance for balanced operation. The E1-G.703/G.704 port adapter cable used depends on the impedance configuration. Further configuration is not necessary.

Each adapter cable provides a D-type connector to the applicable standard interface connector. Custom adapter cables must be ordered as follows:

- 75-ohm unbalanced adapter cable
- 120-ohm balanced adapter cable



Caution The E1-G.703/G.704 port adapter is approved to British Approvals Board of Telecommunications (BABT) Oftel Technical Requirement OTR.001 with a port type of 2DS (telephony traffic carried) or 5C (nontelephony traffic carried), which allows connection to the public 2048-kilobits per second (kbps) network presented with a G.703 interface.

The E1-G.703/G.704 port adapter is not intended to be used in a home environment because of the possible radio interference it might cause.

The E1-G.703/G.704 port adapter should not be connected to cabling that would be required by European Standard/Normative EN60950:1993 to be equipped with overvoltage protection. Only cables supplied by Cisco should be used.

The E1-G.703/G.704 port adapter maintains bit integrity between the network port and the FSIP.

The worst-case delay through the E1-G.703/G.704 port adapter is 125 microseconds.

Useful Information About Safety

Except for Australia, the E1-G.703/G.704 interface to FSIP port is designated SELV within the scope of EN60950:1993.

The FSIP contains SELV circuitry. Ensure that attachments at the interconnection ports of the apparatus are also SELV circuits. SELV circuits are so designed and protected that, under both normal conditions and a likely fault condition, the voltage that can be drawn is not hazardous.

Always disconnect the chassis from the power supply before removing any covers.

Always disconnect the host product chassis from any analog telephone circuits, basic access, or primary access ISDN before removing any screws.

Failure to install the FSIP with E1-G.703/G.704 in accordance with these instructions will invalidate the approval.

If you have any doubt about how to safely install the FSIP with E1-G.703/G.704 correctly within a host chassis, seek advice from a qualified telecommunications engineer or your local Cisco Systems sales office.

Except in Australia, users are reminded that this port should only be connected to SELV ports on other equipment in accordance with EN60950 clause 2.3. The FSIP serial interface is designated an SELV port within the scope of EN41003.

FSIP Power Requirements

This apparatus is intended for use when powered by the FSIP card. The power supply used to power the FSIP is approved to EN41003 and EN60950 producing an SELV output in accordance with EN60950 clause 2.3. The power requirement for the FSIP with E1-G.703/G.704 port adapters installed is 1300 mA at +5 VDC.

It is important to ensure that the power drawn by the apparatus, together with any auxiliary apparatus, lies within the rating of the host power supply.

FSIP with Five-in-One Port Adapter

The Cisco Systems FSIP with five-in-one port adapter assembly is a processor and interface card assembly for use within a range of data communications (gateway and router) chassis supplied by Cisco Systems. The FSIP assembly is a self-contained product that provides all of the hardware and software to allow connections of Cisco's chassis to either digital leased-line circuits (point to point) or to packet-switched public data networks (PSPDNs). The FSIP assembly is fully transportable between compatible host chassis. The choice of each compatible chassis has no effect on the capabilities, functionality, or performance of the FSIP assembly.

The FSIP assembly consists of the following subassemblies:

- FSIP
- Five-in-one serial port adapter card

The FSIP card is a self-contained telecommunications device that provides up to four five-in-one serial port adapters, providing a maximum of eight serial port connections. Each port provides connection to leased lines on packet-switched services of the type X.21, V.24, V.35, and V.36.

Combined, the FSIP and five-in-one serial port adapter card provides all of the hardware necessary for supporting packet-switched public data network (PSPDN) communications. The WAN operating software is resident on the RSP card. Each port of the five-in-one serial port adapter has a custom 50-way connector.

The following port configurations are supported:

- X.21 port for connection to leased lines at up to 2048 kbps or X.25 packet-switched service at up to 64 kbps
- X.24 port for connection to X.21*bis* leased lines or X.25 packet-switched service at up to 19.2 kbps
- V.35 port for connection to X.21*bis* leased lines or X.25 packet-switched service at up to 64 kbps
- V.36 port for connection to X.25 packet-switched service at up to 64 kbps

The final configuration of each serial interface depends on the serial port adapter cable used. The FSIP incorporates cable-sensing circuitry to detect the presence of a specific cable for each service. Further configuration is not necessary. Custom cables are supplied with the apparatus and are as follows:

- X.21 adapter cable
- X.24 adapter cable
- X.35 adapter cable
- X.36 adapter cable

Each cable provides adaption from a 50-way custom connector to the applicable ISO standard connector.

The CE168 marking on the chassis rear panel signifies that the five-in-one port adapter meets European Directive 91/263/EC and has been designed to NET1 and NET2 standards. The marking is shown in Figure 5.

Figure 5 CE168 Marking



CE168X H3125

X.25 Support

X.25 packet-switched support is provided by the operating software resident on the RSP card. This software is designated as Cisco FSIP, X.25 Version 2.0. This software provides both the link- and packet-level facilities of the FSIP assembly.

The operating software is accessed through a VT100 terminal connected to the console port of the RSP card. The settings of the terminal should be as follows:

- Baud: 9600
- Data bits: 8
- Parity: none
- Stop bits: 1

To boot the software, type the following command at the ">" prompt:

```
> b flash
```

(The software now boots from Flash memory.)

Useful Information About Safety

The FSIP assembly contains SELV circuitry. Ensure that attachments at the interconnection ports of the apparatus are also SELV circuits. (SELV circuits are so designed and protected that under both normal conditions and a likely fault condition, the voltage that can be drawn is not hazardous.)

Always disconnect the chassis from the power supply before removing any covers.

Always disconnect the host product chassis from any analog telephone circuits or basic access ISDN (where applicable) before removing any covers.

Failure to install the FSIP assembly in accordance with these instructions will invalidate the approval.

If you have any doubt about how to safely install the Cisco FSIP assembly correctly within a host chassis, consult a qualified telecommunications engineer.

FSIP Power Requirements

The power requirements of the FSIP card (with five-in-one serial port adapter cards installed) are as follows:

- +5 VDC/1300 mA
- +12 VDC/210 mA
- -12 VDC/0 mA

It is important to ensure that the power drawn by the apparatus, together with any auxiliary apparatus, lies within the rating of the host power supply.

MIP Port Adapter with PRI

The MultiChannel Interface Processor (MIP) port adapter with Primary Rate Interface (PRI) is a daughter card connected to a chassis-mounted processor and interface card (MIP) for use within a range of data communications (gateway and router) chassis supplied by Cisco Systems. The PRI-MIP is a self-contained product that provides all of the hardware and software necessary to allow connection of the Cisco 7000 series routers to structured digital leased-line circuits (point to point) using CCITT (ITU-T) recommendation G.703/704 operating at 2 Mbps. The card can also be used on an open structured leased line; however, the framing cannot be disabled. The PRI-MIP is also NET5-compliant for use on Primary Rate ISDN circuits operating at 2 Mbps. The PRI-MIP is fully transportable between compatible host chassis. The choice of each compatible chassis has no effect on capabilities, functionality, or performance of the PRI-MIP.

The PRI-MIP consists of the following subassembly:

- MIP
- PRI port adapter card

The PRI-MIP provides capacity for a maximum of two independent serial port connections. Each port provides connection to 2-Mbps leased lines or Primary Rate ISDN.

Each port on the PRI-MIP port adapter has a 15-pin D-type connector. Each port is configured at the factory to offer either 75-ohm termination impedance for unbalanced operation or 120-ohm termination impedance for balanced operation.

The PRI-MIP port adapter cable used depends on the impedance configuration. Further configuration is not necessary. Each adapter cable provides a D-type connector to the applicable standard interface connector.

Custom adapter cables must be ordered as follows:

- 75-ohm unbalanced adapter cable
- 120-ohm balanced adapter cable

The PRI-MIP port adapter should not be connected to cabling that would be required by European Standard/Normative (EN)60950:1992 to be equipped with overvoltage protection. Only cables supplied by Cisco should be used.

The PRI-MIP port adapter is approved to British Approvals Board of Telecommunications (BABT) Ofel Technical Requirement OTR.001 with a port type of 2DS (telephony traffic carried) or 5C (nontelephony traffic carried), which allows connection to the public 2048-kbps network presented with a G.703 interface.

The PRI-MIP port adapter maintains bit integrity between the network port and the MIP mother card. The worst-case delay through the PRI-MIP port adapter is 125 microseconds.

When the PRI-MIP is configured for 120-ohm balanced operation, the CE168 marking (shown in Figure 6) signifies that this product meets European Directives 94/821/EC and 94/796/EC. In the 75-ohm configuration, the PRI-MIP is in compliance with the U.K. national standard OTR 001.

Figure 6 CE168 Marking



Useful Information About Safety

Except for Australia, the PRI-MIP port is designated SELV within the scope of EN60950:1993.

The PRI-MIP contains SELV circuitry. Ensure that attachments at the interconnection ports of the apparatus are also SELV circuits. SELV circuits are so designed and protected that under both normal conditions and a likely fault condition, the voltage that can be drawn is not hazardous.

Always disconnect the chassis from the power supply before removing any covers.

Always disconnect the host product chassis from any analog telephone circuits, primary access, or basic access ISDN before removing any screws.

Failure to install the PRI-MIP in accordance with these instructions will invalidate the approval.

If you have any doubt about how to safely install the PRI-MIP correctly within a host chassis, consult a qualified telecommunications engineer or your local Cisco sales office.

Note that the host chassis should be connected to earth ground during normal use.

PRI-MIP Power Requirements

The PRI-MIP port adapter card derives its power from the MIP mother card. The power supply used to power the apparatus is approved to EN41003 and EN60950, producing an SELV output in accordance with EN60950 clause 2.3. The power requirement for the PRI-MIP port adapters installed is 1 A at +5 VDC.

It is important to ensure that the power drawn by the apparatus, together with any auxiliary apparatus, lies within the rating of the host power supply.

Channelized T3 Interface Processor (CT3IP)

The Channelized T3 Interface Processor (CT3IP) is used in Cisco 7000 series routers. The CT3IP provides the hardware to connect Cisco 7000 series routers to digital leased-line circuits (point to point) and to packet-switched public data networks (PSPDNs).

The CT3IP has four T1 connections using DB-15 connectors and one DS3 connection using BNC connectors. Each DS3 interface provides up to 28 T1 channels (a single T3 group). Each channel is presented to the system as a serial interface (using a DB-15 connector) that can be configured individually. The CT3IP transmits and receives data bidirectionally at the T1 rate of 1.536 Mbps. The individual T1 connections use 100-ohm, twisted-pair serial cables to external channel service units (CSUs) or to a MIP. External T1 channels do not provide CSU functionality and must connect to an external CSU. The CT3IP supports RFC 1406 (T1 MIB) and RFC 1407 (T3 MIB). For wide-area networking, the CT3IP can function as a concentrator for a remote site. The T3 connection, provided by two female BNC connections for transmit (TX) and receive (RX), has an impedance of 75 ohms. WAN operating software for the CT3IP is bundled with the Cisco IOS software image that is running on the Cisco 7000 series router.

X.25 Support

X.25 packet-switched support is provided by the operating software that is bundled with the Cisco IOS software image. The operating software provides both the link- and packet-level facilities of the CT3IP.

The operating software is accessed through a VT100 terminal connected to the console port of the RSP. The settings of the terminal should be as follows:

- Baud: 9600
- Data bits: 8
- Parity: none
- Stop bits: 1

To boot the software, type the following command at the “>” prompt:

```
> b flash
```

(The software now boots from Flash memory.)

CT3IP Power Requirements

The power requirements of the CT3IP are as follows:

- +5 VDC/2000 mA
- +12 VDC/0 mA
- -12 VDC/0 mA

It is important to ensure that the power drawn by the apparatus, together with any auxiliary apparatus, lies within the rating of the host power supply.

European Union Requirements—CT3IP

The CE168 marking on the CT3IP signifies that the interface processor meets the following European Union directives and standards:

- 94/796/EC (CTR4)
- 94/470/EC (CTR12)
- prTBR13 (June 1994)

The marking is shown in Figure 7.

Figure 7 **CE168 Marking**



The image shows the CE168X marking. The 'C' and 'E' are large and bold, followed by '168X'. To the right of the 'X' is a small vertical text 'H3125'.

The following operating conditions are required within the European Union: The ports marked “Ethernet,” “10BaseT,” “TokenRing,” “FDDI,” “Console,” and “AUX” are SELV circuits. SELV circuits should only be connected to other SELV circuits.

Regarding the connection of a power supply, the Cisco 7000 series routers are intended for use when supplied with AC power from a power source providing 5A maximum at 100 VAC and 2.5A maximum at 240 VAC, 50/60 Hz, with the chassis fully configured.

Other usage will invalidate any approval given to this apparatus if as a result it ceases to comply with EN60950:1992.

United States and Canadian Requirements—CT3IP

The CT3IP meets the United States’ requirements for T1 support as specified in the FCC Part 68 standards.

The CT3IP meets Canadian requirements for T1 support as specified in the CP-01 standards.

VIP2-Based Port Adapters

The following sections provide international agency compliance, safety, and statutory information for specific VIP2-based port adapters that are used in the Cisco 7000 series routers.

The following port adapters are discussed:

- PA-4T Synchronous Serial Port Adapter, page 18
- PA-4T+ Synchronous Serial Port Adapter, page 20
- PA-8T Synchronous Serial Port Adapters, page 22
- PA-H and PA-2H High-Speed Serial Interface Port Adapters, page 24
- Channelized E1 and T1 Port Adapters, page 26
- PA-4E1G-75 and PA-4E1G-120 E1-G.703/G.704 Serial Port Adapters, page 28
- PA-A1 Asynchronous Transfer Mode Port Adapters, page 30
- PA-A3 Asynchronous Transfer Mode Port Adapters, page 30
- PA-2JT2 6.3-MHz Serial Port Adapter, page 32
- PA-E3 and PA-2E3 Serial Port Adapters, page 33
- PA-T3 and PA-2T3 Serial Port Adapters, page 34
- PA-T3+ and 2T3+ Serial Port Adapters, page 34
- PA-MC-E3 Multi-Channel E3 Port Adapter, page 35
- PA-MC-T3 Multi-Channel T3 Port Adapter, page 36
- PA-POS-OC3 Packet OC-3 Port Adapters, page 37
- PA-MC-4T1, PA-MC-8T1, and PA-MC-8DSX1 Multi-Channel DS1/PRI Port Adapters, page 37
- PA-MC-8E1/120 Multi-Channel E1/PRI Port Adapter, page 38

PA-4T Synchronous Serial Port Adapter

The Cisco Systems synchronous serial port adapter is used in Cisco 7000 series routers. The PA-4T port adapter provides the hardware to connect Cisco 7000 series routers to digital leased-line circuits (point to point) and to packet-switched public data networks (PSPDNs).

The PA-4T port adapter has up to four synchronous serial interfaces. Each interface provides a connection to leased lines on packet-switched services of the type X.21, V.24, V.35, and V.36. WAN operating software for the PA-4T port adapter is bundled with the Cisco IOS software image that is running on the Cisco 7000 series router.

Each interface on the PA-4T port adapter is a custom 60-way connector. The following interface configurations are supported:

- X.21 interface for connecting to leased lines at up to 2048 kbps or X.25 packet-switched service at up to 2 Mbps
- X.24 interface for connecting to X.21*bis* leased lines or X.25 packet-switched service at up to 19.2 kbps
- V.35 interface for connecting to X.21*bis* leased lines or X.25 packet-switched service at up to 64 kbps
- V.36 interface for connecting to X.25 packet-switched service at up to 64 kbps

The configuration of an interface depends on the serial port adapter cable attached to the interface. The PA-4T port adapter incorporates cable-sensing circuitry to detect the presence of a specific cable for each service. Further configuration is not necessary. The following Cisco cables are available for the PA-4T port adapter:

- X.21 DTE adapter cable
- X.21 DCE adapter cable
- V.35 DTE adapter cable
- V.35 DCE adapter cable
- RS-232 DTE adapter cable
- RS-232 DCE adapter cable
- RS-449 DTE adapter cable
- RS-449 DCE adapter cable
- RS-530 DTE adapter cable
- RS-530 DCE adapter cable

Each cable provides a connection from a 60-way custom connector to the applicable ISO standard connector.

X.25 Support

X.25 packet-switched support is provided by the operating software that is bundled with the Cisco IOS software image. The operating software provides both the link- and packet-level facilities of the PA-4T port adapter.

The operating software is accessed through a VT100 terminal connected to the console port of the RSP. The settings of the terminal should be as follows:

- Baud: 9600
- Data bits: 8
- Parity: none
- Stop bits: 1

To boot the software, type the following command at the “>” prompt:

```
> b flash
```

(The software now boots from Flash memory.)

Power Requirements

The power requirements of the PA-4T port adapter are as follows:

- +5 VDC/2000 mA
- +12 VDC/120 mA
- -12 VDC/120 mA

It is important to ensure that the power drawn by the apparatus, together with any auxiliary apparatus, lies within the rating of the host power supply.

Approvals

The PA-4T port adapter has received approval from the Japan Approvals Institute for Telecommunications Equipment (JATE). The digital leased-line approval number is N96-K058-0.

European Union Requirements

The CE168 marking on the PA-4T port adapter signifies that the port adapter meets European Directive 96/71/EC and has been designed to CTR2 standards. The marking is shown in Figure 8.

Figure 8 CE168 Marking

CE168X H3125

The following operating conditions are required within the European Union: The ports marked “Ethernet,” “10BaseT,” “TokenRing,” “FDDI,” “Console,” and “AUX” are SELV circuits. SELV circuits should only be connected to other SELV circuits.

Other usage will invalidate any approval given to this apparatus if as a result it ceases to comply with EN60950:1992.

PA-4T+ Synchronous Serial Port Adapter

The Cisco Systems synchronous serial port adapter (PA-4T+) is used in Cisco 7000 series routers. The PA-4T+ port adapter provides the hardware to connect Cisco 7000 series routers to digital leased-line circuits (point to point) and to packet-switched public data networks (PSPDNs).

The PA-4T+ port adapter has up to four synchronous serial interfaces. Each interface provides a connection to leased lines on packet switched services of the type X.21, V.24, V.35, and V.36. WAN operating software for the PA-4T+ port adapter is bundled with the Cisco IOS software image that is running on the Cisco 7000 series router.

Each interface on the PA-4T+ port adapter is a custom 60-way connector. The following interface configurations are supported:

- X.21 interface for connecting to leased lines at up to 2048 kbps or X.25 packet-switched service at up to 2 Mbps
- X.24 interface for connecting to X.21*bis* leased lines or X.25 packet-switched service at up to 19.2 kbps
- V.35 interface for connecting to X.21*bis* leased lines or X.25 packet-switched service at up to 64 kbps
- V.36 interface for connecting to X.25 packet-switched service at up to 64 kbps

The configuration of an interface depends on the serial port adapter cable attached to the interface. The PA-4T+ port adapter incorporates cable-sensing circuitry to detect the presence of a specific cable for each service. Further configuration is not necessary. The following Cisco cables are available for the PA-4T+ port adapter:

- X.21 DTE adapter cable
- X.21 DCE adapter cable
- V.35 DTE adapter cable
- V.35 DCE adapter cable
- RS-232 DTE adapter cable
- RS-232 DCE adapter cable
- RS-449 DTE adapter cable
- RS-449 DCE adapter cable
- RS-530 DTE adapter cable
- RS-530 DCE adapter cable

Each cable provides a connection from a 60-way custom connector to the applicable ISO standard connector.

X.25 Support

X.25 packet-switched support is provided by the operating software that is bundled with the Cisco IOS software image. The operating software provides both the link- and packet-level facilities of the PA-4T+ port adapter.

The operating software is accessed through a VT100 terminal connected to the console port of the RSP. The settings of the terminal should be as follows:

- Baud: 9600
- Data bits: 8
- Parity: none
- Stop bits: 1

To boot the software, type the following command at the “>” prompt:

```
> b flash
```

(The software now boots from Flash memory.)

Power Requirements

The power requirements of the PA-4T+ port adapter are as follows:

- +5 VDC/2000 mA
- +12 VDC/200 mA
- -12 VDC/200 mA

It is important to ensure that the power drawn by the apparatus, together with any auxiliary apparatus, lies within the rating of the host power supply.

Approvals

The PA-4T+ port adapter has received Japan Approvals Institute for Telecommunications Equipment (JATE). The digital leased-line approval number is N97-K012-0.

European Union Requirements

The CE168 marking on the PA-4T+ port adapter signifies that the port adapter meets European Directive 96/71/EC and has been designed to CTR2 standards. The marking is shown in Figure 9.

Figure 9 **CE168 Marking**

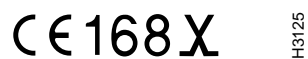

CE168X H3125

The BABT 605567 marking on the PA-4T+ port adapter signifies that the port adapter meets the United Kingdom's requirements for Switched Multimegabit Data Service (SMDS) support as specified in the BABT/TC/130 standards. The marking is shown in Figure 10.

Figure 10 BABT 605567 Marking



The following operating conditions are required within the European Union: The ports marked “Ethernet,” “10BaseT,” “TokenRing,” “FDDI,” “Console,” and “AUX” are SELV circuits. SELV circuits should only be connected to other SELV circuits.

Other usage will invalidate any approval given to this apparatus if as a result it ceases to comply with EN60950:1992.

PA-8T Synchronous Serial Port Adapters

The PA-8T synchronous serial port adapters are used in Cisco 7000 series routers. The PA-8T port adapters provide the hardware to connect Cisco 7000 series routers to digital leased-line circuits (point to point) and to packet-switched public data networks (PSPDNs). The three PA-8T port adapters are as follows:

- PA-8T-V35
- PA-8T-X21
- PA-8T-232

Each PA-8T port adapter has up to eight V.35, X21, or EIA/TIA-232 synchronous serial interfaces (all interfaces on each PA-8T port adapter are of the same type). Each interface provides a connection to leased lines on packet switched services of the type V.35, X21, or EIA/TIA-232. WAN operating software for the PA-8T port adapters is bundled with the Cisco IOS software image that is running on the Cisco 7000 series router.

On each PA-8T port adapter, all eight interfaces are accessible through a single port that has a custom 200-way connector. The interface types (V.35, X21, or EIA/TIA-232) supported by each PA-8T port adapter are for connecting to X.21*bis* leased lines or X.25 packet-switched service at up to 2 Mbps.

The mode (DCE or DTE) of an PA-8T port adapter interface depends on the compact serial cable attached to the single PA-8T port. The following Cisco compact serial cables are available for the PA-8T port adapter:

- V.35 DTE mode with 34-pin Winchester-type V.35 plugs on the network end
- V.35 DCE mode with 34-pin Winchester-type V.35 receptacles on the network end
- X.21 DTE mode with 34-pin Winchester-type X.21 plugs on the network end
- X.21 DCE mode with 34-pin Winchester-type X.21 receptacles on the network end
- EIA/TIA-232 DTE mode with 34-pin Winchester-type EIA/TIA-232 plugs on the network end
- EIA/TIA-232 DCE mode with 34-pin Winchester-type EIA/TIA-232 receptacles on the network end

Each cable provides a connection from a 200-way custom connector to the applicable ISO standard connector.

X.25 Support

X.25 packet-switched support is provided by the operating software that is bundled with the Cisco IOS software image. The operating software provides both the link- and packet-level facilities of each PA-8T port adapter. The operating software is accessed through a VT100 terminal connected to the console port of the RSP. The settings of the terminal should be as follows:

- Baud: 9600
- Data bits: 8
- Parity: none
- Stop bits: 1

To boot the software, type the following command at the “>” prompt:

```
> b flash
```

(The software now boots from Flash memory.)

Switched Multimegabit Data Service Support

Switched Multimegabit Data Service Support (SMDS) packet-switched, datagram-based support is provided by the operating software that is bundled with the Cisco IOS software image. The operating software provides both the link- and packet-level facilities of the PA-8T port adapters.

Power Requirements

The power requirements of the PA-8T-V35 port adapter are as follows:

- +5 VDC/1800 mA
- +12 VDC/290 mA
- -12 VDC/120 mA

The power requirements of the PA-8T-X21 port adapter are as follows:

- +5 VDC/2200 mA
- +12 VDC/0 mA
- -12 VDC/0 mA

The power requirements of the PA-8T-232 port adapter are as follows:

- +5 V*DC/1800 mA
- +12 VDC/120 mA
- -12 VDC/120 mA

It is important to ensure that the power drawn by the apparatus, together with any auxiliary apparatus, lies within the rating of the host power supply.

Approvals

The PA-8T-V35 port adapter has received approval from the Japan Approvals Institute for Telecommunications Equipment (JATE). The digital leased-line approval number is N96-K073-0.

The PA-8T-X21 port adapter has received approval from the Japan Approvals Institute for Telecommunications Equipment (JATE). The digital leased-line approval number is N96-N158-0.

The PA-8T-232 port adapter has received approval from the Japan Approvals Institute for Telecommunications Equipment (JATE). The digital leased-line approval number is N96-N218-0.

European Union Requirements

The CE168 marking on the PA-8T port adapters signifies that the port adapters meet European Directive 91/263/EC and has been designed to CTR2 standards. The marking is shown in Figure 11.

Figure 11 CE168 Marking



The BABT 605560 marking on the PA-8T-V35 port adapter signifies that the port adapter meets the United Kingdom's requirements for Switched Multimegabit Data Service (SMDS) support as specified in the BABT/TC/130 standards. The marking is shown in Figure 12.

Figure 12 BABT 605560 Marking

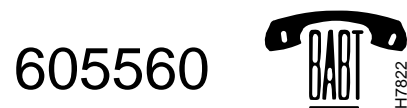

The following operating conditions are required within the European Union: The ports marked "Ethernet," "10BaseT," "TokenRing," "FDDI," "Console," and "AUX" are SELV circuits. SELV circuits should only be connected to other SELV circuits.

Other usage will invalidate any approval given to this apparatus if as a result it ceases to comply with EN60950:1992.

PA-H and PA-2H High-Speed Serial Interface Port Adapters

The High-Speed Serial Interface (HSSI) port adapters (PA-H Rev. B and PA-2H Rev. B) are used in Cisco 7000 series routers. The HSSI port adapters provide the hardware to connect Cisco 7000 series routers to digital leased-line circuits (point to point) and to packet-switched public data networks (PSPDNs).

The HSSI port adapters provide one or two high-speed serial interfaces. WAN operating software for the HSSI port adapters is bundled with the Cisco IOS software image that is running on the Cisco 7000 series router.

Each HSSI interface is a custom 50-way connector, which provides full-duplex (FDX) synchronous serial functionality for transmitting and receiving data at rates of up to 52 Mbps.

Two types of cables are available for use with the HSSI port adapters: the HSSI interface cable used to connect your router to an external DSU (and HSSI network) and a null modem cable, which allows you to connect two routers back to back. Each port on an HSSI port adapter is considered to be a DTE device. The cable provides a connection from a 50-way custom connector to the applicable ISO standard connector.

X.25 Support

X.25 packet-switched support is provided by the operating software that is bundled with the Cisco IOS software image. The operating software provides both the link- and packet-level facilities of the HSSI port adapter. The operating software is accessed through a VT100 terminal connected to the console port of the RSP. The settings of the terminal should be as follows:

- Baud: 9600
- Data bits: 8
- Parity: none
- Stop bits: 1

To boot the software, type the following command at the “>” prompt (the software will then boot from Flash memory):

```
> b flash
```

(The software now boots from Flash memory.)

Switched Multimegabit Data Service Support

Switched Multimegabit Data Service (SMDS) packet-switched, datagram-based support is provided by the operating software that is bundled with the Cisco IOS software image. The operating software provides both the link- and packet-level facilities of the HSSI port adapter.

Power Requirements

The power requirements of the HSSI port adapter are as follows:

- +5 VDC/1300 mA
- +12 VDC/850 mA
- -12 VDC/0 mA

It is important to ensure that the power drawn by the apparatus, together with any auxiliary apparatus, lies within the rating of the host power supply.

European Union Requirements

The BABT 605559 marking on the HSSI port adapter signifies that the port adapter meets the United Kingdom’s requirements for Switched Multimegabit Data Service (SMDS) and HSSI support as specified in the BABT/TC/130 standards. The marking is shown in Figure 13.

Figure 13 **BABT 605559 Marking**

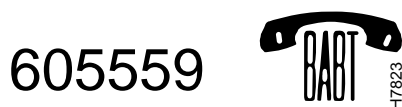

Channelized E1 and T1 Port Adapters

The channelized E1 port adapters (PA-2CE1/PRI-75 and PA-2CE1/PRI-120) and the channelized T1 port adapter (PA-2CT1/PRI) are used in Cisco 7000 series routers. The PA-CE1 and PA-CT1 port adapters provide the hardware to connect Cisco 7000 series routers to digital leased-line circuits (point to point) and to packet-switched public data networks (PSPDNs).

The PA-2CE1/PRI-75 (unbalanced 75-ohm) and PA-2CE1/PRI-120 (balanced 120-ohm) provide up to two channelized E1 network interfaces to connect to channel service units (CSUs). Each 2CE1 interface transmits and receives data bidirectionally at the E1 rate of 2.048 Mbps. The PA-2CT1/PRI provides up to two channelized T1 network interfaces to connect to CSUs. Each 2CT1 interface can transmit and receive data bidirectionally at the T1 rate of 1.544 Mbps. WAN operating software for the PA-2CE1 and PA-2CT1 port adapters is bundled with the Cisco IOS software image that is running on the Cisco 7000 series router.

Three G.703 serial interface cables are available from Cisco and other vendors for use with the PA-2CE1 port adapters: two cables for balanced 120-ohm PA-2CE1 interface connections, and one cable for an unbalanced 75-ohm PA-2CE1 interface connection. Following are the Cisco cables available for the PA-2CE1 port adapters:

- Twinax adapter cable for balanced 120-ohm connections
- RJ-45 adapter cable for balanced 120-ohm connections
- BNC adapter cable for unbalanced 75-ohm connections

The following standard null-modem and straight-through serial interface cables are available from Cisco and other vendors for use with the PA-2CT1 port adapter:

- Null-modem adapter cable
- Straight-through adapter cable

Each PA-2CE1 and PA-2CT1 cable provides a connection from a 15-way custom connector to the applicable ISO standard connector.

Power Requirements

The power requirements of the PA-2CE1 and PA-2CT1 port adapters are as follows:

- +5 VDC/2000 mA
- +12 VDC/0 mA
- -12 VDC/0 mA

It is important to ensure that the power drawn by the apparatus, together with any auxiliary apparatus, lies within the rating of the host power supply.

Approvals

The PA-2CT1 port adapter has received approval from the Japan Approvals Institute for Telecommunications Equipment (JATE). The ISDN approval number is T97-6301-0 and the digital leased-line approval number is N97-K005-0.

The PA-2CT1 port adapter meets Hong Kong's requirements as specified in the Ref. Letter 037/97/CCF.

The PA-2CT1 port adapter meets Taiwan's requirements as specified by approval number 186-5041-0.

The PA-2CE1/PRI-75 port adapter meets Belgium's requirements as specified in the BE-SP-103 standard and has received approval number BE97DC0081.

The PA-2CE1/PRI-75 port adapter meets Sweden's requirements as specified in the SS 63 63 34 standard and has received approval number 97020410.

The PA-2CE1 port adapter meets New Zealand's requirements as specified by approval number PTC 232/97/004.

The PA-2CE1 port adapter meets Australia's requirements as specified by approval number A97/205.

The PA-2CE1/PRI-75 port adapter meets The Netherlands' requirements for unbalanced 75-ohm E1 support as specified in the T10-00 (June 16, 1992) and T14-03 (August 30, 1988) standards.

The PA-2CE1 port adapter meets Singapore's requirements.

European Union Requirements

The CE168 marking on the PA-2CE1 port adapters signifies that the port adapter meets the following European Union directives and standards:

- 94/796/EC (CTR4)
- 94/470/EC (CTR12)
- prTBR13 (June 1994)

The marking is shown in Figure 14.

Figure 14 CE168 Marking

CE168X H3125

The BAPT 605565 marking on the PA-2CE1/PRI-75 port adapter signifies that the port adapter meets the United Kingdom's requirements for unbalanced 75-ohm E1 support as specified in the NTR4 (PD7024:1995) standards.

The marking is shown in Figure 15.

Figure 15 BAPT 605565 Marking

605565  H10413

United States and Canadian Requirements

The PA-2CT1 port adapter meets the United States' requirements for T1 support as specified in the FCC Part 68 standards.

The PA-2CT1 port adapter meets Canadian requirements for T1 support as specified in the CP-01 standards.

PA-4E1G-75 and PA-4E1G-120 E1-G.703/G.704 Serial Port Adapters

The PA-4E1G-75 and PA-4E1G-120 are chassis-mounted processor-card based port adapters for use within a range of data communications (gateway and router) chassis supplied by Cisco Systems. The PA-4E1G-75 and PA-4E1G-120 port adapters are products that, when used with the VIP2 cards, provide all of the hardware and software to allow connection of Cisco's chassis to digital leased-line circuits (point to point) using CCITT (ITU-T) recommendation G.703 operating protocols at speeds up to 2 Mbps. The PA-4E1G-75 and PA-4E1G-120 port adapters are fully transportable between compatible *host* chassis. The choice of each compatible chassis has no effect on capabilities, functionality, or performance of the PA-4E1G-75 and PA-4E1G-120 port adapters.

The VIP2 accommodates up to two PA-4E1G-75 and PA-4E1G-120 port adapters providing a maximum of eight serial port connections. Each port can provide connection to 2-Mbps leased lines. Combined, the PA-4E1G-75 and PA-4E1G-120 port adapters provide all of the hardware necessary for supporting leased-line communications.

Each port on the PA-4E1G-75 and PA-4E1G-120 port adapters has a 15-pin D-type connector. Each port is configured at the factory to offer either 75-ohm termination impedance for unbalanced operation or a 120-ohm termination impedance for balanced operation. The PA-4E1G-75 and PA-4E1G-120 port adapter cable used depends on the impedance configuration. Further configuration is not necessary.

Each adapter cable provides a D-type connector to the applicable standard interface connector. Custom adapter cables must be ordered as follows:

- 75-ohm unbalanced adapter cable
- 120-ohm balanced adapter cable

Each cable provides adaption from a 15-pin connector to the applicable ISO standard connector. The CE168 marking signifies that the port adapters meet European Directive 91/263/EC, and have been designed to NET1 and NET2 standards.

The CE168 marking on the PA-4E1G-120 port adapter signifies that the port adapter meets the following European Union directives and standards:

- 94/470/EC (CTR12)
- prTBR13 (Sept. 1995)
- NTR4 (PD7024)

The marking is shown in Figure 16.

Figure 16 CE168 Marking

CE168X H3125

The PA-4E1G-75 and PA-4E1G-120 port adapters are approved by British Approvals Board of Telecommunications (BABT) to OfTel Technical Requirement OTR.001 with a port type of 2DS (telephony traffic carried) or 5C (nontelephony traffic carried), which allows connection to the public 2048-kbps network presented with a G.703 interface.



Caution The PA-4E1G-75 and PA-4E1G-120 port adapters are not intended to be used in a home environment, because of the possible radio interference they might cause.

The PA-4E1G-75 and PA-4E1G-120 port adapters should not be connected to cabling that would be required by European Standard/Normative EN60950:1992 to be equipped with overvoltage protection. Only cables supplied by Cisco should be used.

The PA-4E1G-75 and PA-4E1G-120 port adapters maintain bit integrity between the network port and the VIP2.

The worst-case delay through the PA-4E1G-75 and PA-4E1G-120 port adapters is 125 microseconds (S).

Power Requirements

The power requirements of the PA-4E1G-75 and PA-4E1G-120 port adapters are as follows:

- +5 VDC/1300 mA
- +12 VDC/0 mA
- -12 VDC/0 mA

It is important to ensure that the power drawn by the apparatus, together with any auxiliary apparatus, lies within the rating of the host power supply.

Approvals

The PA-4E1G-120 (balanced) port adapter meets the European Union's requirements as specified by approval number CE0168X.

The PA-4E1G-120 (balanced) port adapter meets Singapore's requirements.

The PA-4E1G-75 (unbalanced) port adapter meets the United Kingdom's requirements as specified by approval number 607113.

The PA-4E1G-75 (unbalanced) port adapter meets The Netherlands' requirements as specified by approval number NL 97211179.

The PA-4E1G-75 (unbalanced) port adapter meets Belgium's requirements as specified by approval number BE97DC0512.

Useful Information About Safety

The following operating conditions are required within the European Union: The ports marked "Ethernet," "10BaseT," "TokenRing," "FDDI," "Console," and "AUX" are SELV circuits. SELV circuits should only be connected to other SELV circuits.

Other usage will invalidate any approval given to this apparatus if as a result it ceases to comply with EN60950:1992.

Except in Australia, users are reminded that this port should only be connected to SELV ports on other equipment in accordance with EN60950 clause 2.3. The PA-4E1G-75 and PA-4E1G-120 serial interface is designated an SELV port within the scope of EN60950:1992.

PA-A1 Asynchronous Transfer Mode Port Adapters

The PA-A1 Asynchronous Transfer Mode (ATM) port adapters (PA-A1-OC3SMI [single-mode intermediate reach] and PA-A1-OC3MM [multimode long reach]) provide the hardware necessary to connect Cisco 7000 series routers to ATM switching fabrics for transmitting and receiving data at rates of up to 155 Mbps bidirectionally for OC-3. Each port adapters' single OC-3 interface has two SC-type duplex connectors.

The PA-A1 port adapters require an OC-3 single-mode ATM cable with SC-type connectors. This cable provides a connection from SC-type connectors to the applicable ISO standard connector. Cisco Systems does not provide the cable; it is available from commercial cable vendors.

Power Requirements

Following are the power requirements for the PA-A1 port adapters:

- +5 VDC/2200 mA
- +12 VDC/0 mA
- -12 VDC/0 mA

It is important to ensure that the power drawn by the apparatus, together with any auxiliary apparatus, lies within the rating of the host power supply.

United States Requirements

The PA-A1 port adapters meet the United States' requirements as a Class B digital device in accordance with the specifications in part 15 of the FCC rules.

PA-A3 Asynchronous Transfer Mode Port Adapters

The following PA-A3 port adapters provide the hardware necessary to connect Cisco 7000 series routers to ATM switching fabrics for transmitting and receiving data at rates of up to 155 Mbps bidirectionally for OC-3, 44.736 Mbps bidirectionally for DS3 over T3, and 34 Mbps bidirectionally for E3:

- PA-A3-T3
- PA-A3-E3
- PA-A3-OC3MM (multimode)
- PA-A3-OC3SMI (single-mode intermediate reach)
- PA-A3-OC3SML (single-mode long reach)

The port adapters' single T3 and E3 interfaces have two BNC-type connectors and the single OC-3 interface has two SC-type connectors.

Following are the required interface cables for the PA-A3 port adapters:

- OC-3 single-mode ATM cable with SC-type connectors. This cable provides a connection from SC-type connectors to the applicable ISO standard connector. Cisco Systems does not provide the cable; it is available from commercial cable vendors.
- T3/E3 75-ohm coaxial cable with BNC-type connectors. Cisco Systems provides this cable in five different lengths: 10, 25, 50, and 100 feet (3.05, 7.62, 15.24, and 30.48 meters). These cables provide a connection from BNC-type connectors to the applicable ISO standard connector. Following are the Cisco Systems T3/E3 75-ohm coaxial cables:
 - T3/E3 interface coaxial cable, 10 feet
 - T3/E3 interface coaxial cable, 25 feet
 - T3/E3 interface coaxial cable, 50 feet
 - T3/E3 interface coaxial cable, 75 feet
 - T3/E3 interface coaxial cable, 100 feet

Power Requirements

Following are the power requirements for the PA-A3 port adapters:

- +5 VDC/2000 mA
- +12 VDC/0 mA
- -12 VDC/0 mA

It is important to ensure that the power drawn by the apparatus, together with any auxiliary apparatus, lies within the rating of the host power supply.

Approvals

The PA-A3-T3 port adapter meets Japan's requirements as specified by digital leased-line approval number N98-N324-0. The PA-A3-OC3-SMI port adapter meets Japan's requirements as specified by digital leased-line approval number N98-3009-0. The PA-A3-OC3-SML port adapter meets Japan's requirements as specified by digital leased-line approval number N98-3010-0.

The A-tick marking on the PA-A3 port adapters indicates that the port adapters meet Australian TS016 and TS026 requirements.

United States Requirements

The PA-A3 port adapters meet the United States' requirements as a Class A digital device in accordance with the specifications in part 15 of the FCC rules.

European Union Requirements

The CE168 marking on the PA-A3 port adapters signifies that the port adapters meet the following standard: 97/639/EC (CTR24). Figure 17 shows the marking.

Figure 17 **CE168 Marking**

CE168X H3125

PA-2JT2 6.3-MHz Serial Port Adapter

The PA-2JT2 port adapter is a two-port port adapter for the VIP2 card. It permits routers to communicate over a 6.3-Mbps leased-line service. The PA-2JT2 port adapter is a product that, when used in conjunction with the VIP2 cards, provides all of the hardware and software to allow connection of Cisco 7000 series chassis to digital leased-line circuits (point to point) at speeds up to 6.3 Mbps.

The PA-2JT2 port adapter is fully transportable between compatible host chassis. The choice of each compatible chassis has no effect on capabilities, functionality, or performance of the PA-2JT2 port adapter. The VIP2 accommodates up to two PA-2JT2 port adapters providing a maximum of four serial port connections. Each port can provide connection to 6.3-Mbps leased lines. The PA-2JT2 port adapter provides all of the hardware for supporting leased-line communications.

Each port on the PA-2JT2 port adapter has two BNC connectors: receive and transmit. Each port is configured at the factory to offer a 75-ohm termination impedance for unbalanced operation. Further configuration is not necessary.

Each adapter cable must provide coaxial CO2-type connectors, which are equivalent to MIL C 3608 BNC connectors. Custom adapter cables must be ordered as unbalanced 75-ohm (5 percent at 1 MHz) coaxial BNC cables. Ideally, the maximum cable length for unbalanced 75-ohm coaxial cable is 1968.5 feet (600 meters). The coaxial cable's loss must be less than 6 dB when maximum cable lengths are used. To prevent problems, you *must* check your 75-ohm coaxial cable's specifications when long cable lengths are required to connect the PA-JT2 port adapter to your data service unit (DSU). Unbalanced PA-JT2 interfaces allow for a longer maximum cable length than those specified for balanced circuits.

To prevent system grounding and signal problems, your DSU *must* be set to accept an external ground because the PA-2JT2 port adapter's transmit and receive connections are grounded at the router-chassis side.

Power Requirements

The PA-2JT2 port adapter is intended for use when powered by the VIP2 card. The power supply used to power the VIP2 is approved to EN41003 and EN60950 producing an SELV output in accordance with EN60950 clause 2.3. The power requirement for the VIP2 with the PA-2JT2 port adapter installed is 1700 mA at +5 VDC.

It is important to ensure that the power drawn by The PA-2JT2 port adapter, together with any auxiliary apparatus, lies within the rating of the host power supply.

Approvals

The PA-2JT2 port adapter has received approval from the Japan Approvals Institute for Telecommunications Equipment (JATE). The digital leased-line approval number is N97-K013-0.

PA-E3 and PA-2E3 Serial Port Adapters

The PA-E3 and PA-2E3 synchronous serial port adapters are used in Cisco 7000 series routers. The PA-E3 and PA-2E3 port adapters provide E3 interfaces for connecting Cisco 7000 series routers to E3 networks; each interface transmits and receives data at rates of up to 34 Mbps full-duplex.

The PA-E3 and PA-2E3 port adapters provide one or two E3 interfaces that have two or four BNC connectors: receive and transmit. The adapter cable for the PA-E3 port adapter is a 10-foot (3.05-meter) 75-ohm coaxial cable with BNC connectors. This cable provides a connection from BNC-type connectors to the applicable ISO standard connector. The adapter cable is available only from Cisco Systems.

Power Requirements

Following are the power requirements for the PA-E3 and the PA-2E3 port adapters:

- +5 VDC/2000 mA
- +12 VDC/83 mA
- -12 VDC/0 mA

It is important to ensure that the power drawn by the apparatus, together with any auxiliary apparatus, lies within the rating of the host power supply.

Approvals

The PA-E3 port adapter meets The Netherlands' requirements as specified by approval number NL 97091803.

European Union Requirements

The CE168 marking on the PA-E3 and PA-2E3 port adapters signifies that the port adapters meet the prTBR24 standard.

The marking is shown in Figure 18.

Figure 18 CE168 Marking



The BABT 607116 marking on the PA-E3 and PA-2E3 port adapters signifies that the port adapters meet the European Union's requirements for E3 support as specified in the prTBR24 standards. The marking is shown in Figure 19.

Figure 19 BABT 607116 Marking



PA-T3 and PA-2T3 Serial Port Adapters

The PA-T3 and PA-2T3 synchronous serial port adapters are used in Cisco 7000 series router. The PA-E3 and PA-2E3 port adapters provide T3 interfaces for connecting Cisco 7000 series routers to T3 networks; each interface transmits and receives data at rates of up to 45 Mbps full-duplex.

The PA-T3 and PA-2T3 port adapters provide one or two T3 interfaces that have two or four BNC receptacles (receive and transmit), respectively. The adapter cable for the PA-T3 port adapter is a 10-foot (3.05-meter) 75-ohm coaxial cable with BNC connectors. This cable provides a connection from BNC-type connectors to the applicable ISO standard connector and is available only from Cisco Systems.

Power Requirements

Following are the power requirements for the PA-T3 and the PA-2T3 port adapters:

- +5 VDC/2000 mA
- +12 VDC/83 mA
- -12 VDC/0 mA

It is important to ensure that the power drawn by the apparatus, together with any auxiliary apparatus, lies within the rating of the host power supply.

Approvals

The PA-T3 port adapter meets Japan's requirements as specified by digital leased-line approval number N98-N325-0. The PA-2T3 port adapter meets Japan's requirements as specified by digital leased-line approval number N98-N326-0.

PA-T3+ and 2T3+ Serial Port Adapters

The PA-T3+ and PA-2T3+ synchronous serial port adapters provide T3 interfaces for connecting Cisco 7000 series routers to T3 networks; each interface transmits and receives data at rates of up to 45 Mbps, full-duplex.

The PA-T3+ and PA-2T3+ port adapters provide one or two T3 interfaces that have two or four BNC receptacles (receive and transmit), respectively. The adapter cable (Product Number CAB-ATM-DS3/E3=) for the PA-T3+ and PA-2T3+ port adapters is a 10-foot (3.05-meter) 75-ohm coaxial cable with BNC connectors. This cable provides a connection from BNC-type connectors to the applicable ISO standard connector and is available only from Cisco Systems.

Power Requirements

Following are the power requirements for the PA-T3+ and the PA-2T3+ port adapters:

- +5 VDC/2000 mA
- +12 VDC/83 mA
- -12 VDC/0 mA

It is important to ensure that the power drawn by the apparatus, together with any auxiliary apparatus, lies within the rating of the host power supply.

Approvals

The PA-T3+ port adapter meets Japan's requirements as specified by digital leased-line approval number N98-N358-0. The PA-2T3+ port adapter meets Japan's requirements as specified by digital leased-line approval number N98-N359-0.

United States Requirements

The PA-T3+ and PA-2T3+ port adapters meet the United States' requirements as a Class A digital device in accordance with the specifications in part 15 of the FCC rules.

PA-MC-E3 Multi-Channel E3 Port Adapter

The multi-channel E3 (MC-E3) synchronous serial port adapter (PA-MC-E3) provides one multi-channel E3 interface for connecting Cisco 7000 series routers to E3 networks; the single interface transmits and receives data at rates of up to 34 Mbps full-duplex.

The PA-MC-E3 port adapter provides one E3 interface that has two BNC connectors (receive and transmit). The adapter cable for the PA-MC-E3 port adapter is a 75-ohm coaxial cable pair with ferrite beads attached (Product Number CAB-ATM-DS3/E3=). This 75-ohm coaxial cable pair is available from Cisco Systems.

Power Requirements

Following are the power requirements for the PA-MC-E3 port adapter:

- +5 VDC/2000 mA
- +12 VDC/0 mA
- -12 VDC/0 mA

It is important to ensure that the power drawn by the apparatus, together with any auxiliary apparatus, lies within the rating of the host power supply.

Approvals

The A-tick marking on the PA-MC-E3 port adapter indicates that the port adapter meets Australian TS016 requirements.

European Union Requirements

The CE168 marking on the PA-MC-E3 port adapter signifies that the port adapter meets the 97/639/EC (CTR24) standard.

Figure 20 shows the marking.

Figure 20 **CE168 Marking**

CE168X H3125

PA-MC-T3 Multi-Channel T3 Port Adapter

The multi-channel T3 (MC-T3) synchronous serial port adapter (PA-MC-T3) provides one multi-channel T3 interface for connecting Cisco 7000 series routers to T3 networks; the single interface transmits and receives data at rates of up to 44.736 Mbps full-duplex.

The PA-MC-T3 port adapter provides one T3 interface that has two BNC connectors (receive and transmit). The adapter cable for the PA-MC-E3 port adapter is a 75-ohm coaxial cable pair with ferrite beads attached (Product Number CAB-ATM-DS3/E3=). This 75-ohm coaxial cable pair is available from Cisco Systems.

Power Requirements

Following are the power requirements for the PA-MC-T3 port adapter:

- +5 VDC/2000 mA
- +12 VDC/0 mA
- -12 VDC/0 mA

It is important to ensure that the power drawn by the apparatus, together with any auxiliary apparatus, lies within the rating of the host power supply.

Approvals

The PA-MC-T3 port adapter meets Japan's requirements as specified by the digital leased-line approval number N98-N325-0.

United States Requirements

The PA-MC-T3 port adapter meets the United States' requirements as a Class A digital device in accordance with the specifications in part 15 of the FCC rules.

PA-POS-OC3 Packet OC-3 Port Adapters

The Packet-over-SONET (POS) OC-3 port adapters (PA-POS-OC3SML [single-mode long reach], PA-POS-OC3SMI [single-mode intermediate reach], and PA-POS-OC3MM [multimode]) provide a single Packet OC-3 network interface for connecting Cisco 7000 series routers to optical fiber OC-3 networks. The single OC-3 interface transmits and receives data at rates of up to 155 Mbps full-duplex. (Half-duplex operation is not supported.)

Each PA-POS-OC3 port adapter provides one Packet OC-3 interface that has two SC-type receptacles to allow connection to single-mode or multimode optical fiber. For the PA-POS-OC3 port adapter, the single-mode optical fiber you should use should have a modal-field diameter of 8.7 0.5 microns. (The nominal diameter is approximately 10/125 microns.) The multimode optical fiber you should use should have a core/cladding diameter of 62.5/125 microns. Single-mode and multimode optical fiber cables for the PA-POS-OC3 port adapter are not available from Cisco Systems; they are available from commercial cable vendors.

Power Requirements

Following are the power requirements for the PA-POS-OC3 port adapters:

- +5 VDC/2200mA
- +12 VDC/0mA
- -12 VDC/0mA

It is important to ensure that the power drawn by the apparatus, together with any auxiliary apparatus, lies within the rating of the host power supply.

United States and Canadian Requirements

The PA-POS-OC3 port adapters meet the United States' requirements as a Class A digital device in accordance with the specifications in part 15 of the FCC rules.

PA-MC-4T1, PA-MC-8T1, and PA-MC-8DSX1 Multi-Channel DS1/PRI Port Adapters

The multi-channel DS1/PRI port adapters (PA-MC-4T1, PA-MC-8T1, and PA-MC-8DSX1) integrate channel service unit (CSU) and data service unit (DSU) functionality and DS0 channel support into Cisco 7000 series routers. The PA-MC-8DSX1 port adapter also integrates DS1 data service unit functionality and DS0 channel support into Cisco 7000 series routers. Each multi-channel DS1/PRI port adapter can provide up to 128 separate full-duplex High-Level Data Link Control (HDLC) DS0, fractional, or full T1 channels.

The eight DS1/PRI interface receptacles on the multi-channel DS1/PRI port adapter are RJ-48C for T1 (100-ohm) that do not require an external transceiver. You can use all eight simultaneously. Each connection supports T1(100-ohm) interfaces that meet T1.403 and ACCUNET TR62411 standards and requires 100-ohm shielded twisted-pair cables. These cables are not available from Cisco Systems; they are available from outside commercial cable vendors.

Following are the power requirements for the PA-MC-4T1 port adapter:

- +5 VDC/1300 mA
- +12 VDC/3 mA
- -12 VDC/0 mA

Following are the power requirements for the PA-MC-8T1 and PA-MC-8DSX1 port adapters:

- +5 VDC/1700 mA
- +12 VDC/3 mA
- -12 VDC/0 mA

It is important to ensure that the power drawn by the apparatus, together with any auxiliary apparatus, lies within the rating of the host power supply.

Approvals

The PA-MC-4T1 port adapter meets Japan's requirements as specified by ISDN approval number T98-6318-0.

The PA-MC-8T1 and PA-MC-8DSX1 port adapters meet Japan's requirements as specified by ISDN approval number T98-6317-0.

United States Requirements

The multi-channel DS1/PRI port adapters meet the United States' requirements as a Class A digital device in accordance with the specifications in part 15 of the FCC rules.

PA-MC-8E1/120 Multi-Channel E1/PRI Port Adapter

The multi-channel E1/PRI port adapter (PA-MC-8E1/120) integrates E1 channel support into the Cisco 7000 series routers. Each PA-MC-8E1/120 port adapter provides up to 128 separate full-duplex High-Level Data Link Control (HDLC) E1, fractional, or full E1 channels.

The eight E1/PRI interface receptacles on the PA-MC-8E1/120 port adapter are RJ-48C for E1 (120-ohm) that do not require an external transceiver. You can use all eight receptacles simultaneously. Each connection supports E1 (120-ohm) interfaces that meet G.703 standards and requires 120-ohm unshielded twisted-pair cables. These cables are not available from Cisco Systems; they are available from outside commercial cable vendors.

Following are the power requirements for the PA-MC-8E1/120 port adapter:

- +5 VDC/1700 mA
- +12 VDC/3 mA
- -12 VDC/0 mA

It is important to ensure that the power drawn by the apparatus, together with any auxiliary apparatus, lies within the rating of the host power supply.

Approvals

The A-tick marking on the PA-MC-8E1/120 port adapter indicates that the port adapter meets Australian TS014, TS016, and TS038 requirements.

European Union Requirements

The CE168 marking on the PA-MC-8E1/120 port adapter signifies that the port adapter meets the following standards:

- 97/520/EC (CTR12)
- 97/521/EC (CTR13)
- 97/470/EC (CTR12)
- 97/347/EC (CTR4)

Figure 21 shows the marking.

Figure 21 CE168 Marking

CE168X H3125

The BABT 607116 marking on the PA-MC-8E1/120 port adapter signifies that the port adapter meets United Kingdom directive 607116 and has been designed to BABT standards. Figure 22 shows the marking.

Figure 22 BABT 607116 Marking

607116  H10897

Translated Safety Warnings

This section repeats in multiple languages the warnings in this publication. In addition, this section contains translated warnings that can be used with other documentation related to the Cisco 7000 series routers, such as the documents for the Cisco 7000 series field-replaceable units.

Warning Definition



Warning This warning symbol means *danger*. You are in a situation that could cause bodily injury. Before you work on any equipment, be aware of the hazards involved with electrical circuitry and be familiar with standard practices for preventing accidents.

Waarschuwing Dit waarschuwingssymbool betekent gevaar. U verkeert in een situatie die lichamelijk letsel kan veroorzaken. Voordat u aan enige apparatuur gaat werken, dient u zich bewust te zijn van de bij elektrische schakelingen betrokken risico's en dient u op de hoogte te zijn van standaard maatregelen om ongelukken te voorkomen.

Varoitus Tämä varoitusmerkki merkitsee vaaraa. Olet tilanteessa, joka voi johtaa ruumiinvammaan. Ennen kuin työskentelet minkään laitteiston parissa, ota selvää sähkökytkentöihin liittyvistä vaaroista ja tavanomaisista onnettomuuksien ehkäisykeinoista.

Attention Ce symbole d'avertissement indique un danger. Vous vous trouvez dans une situation pouvant causer des blessures ou des dommages corporels. Avant de travailler sur un équipement, soyez conscient des dangers posés par les circuits électriques et familiarisez-vous avec les procédures couramment utilisées pour éviter les accidents.

Warnung Dieses Warnsymbol bedeutet Gefahr. Sie befinden sich in einer Situation, die zu einer Körperverletzung führen könnte. Bevor Sie mit der Arbeit an irgendeinem Gerät beginnen, seien Sie sich der mit elektrischen Stromkreisen verbundenen Gefahren und der Standardpraktiken zur Vermeidung von Unfällen bewusst.

Avvertenza Questo simbolo di avvertenza indica un pericolo. La situazione potrebbe causare infortuni alle persone. Prima di lavorare su qualsiasi apparecchiatura, occorre conoscere i pericoli relativi ai circuiti elettrici ed essere al corrente delle pratiche standard per la prevenzione di incidenti.

Advarsel Dette varselsymbolet betyr fare. Du befinner deg i en situasjon som kan føre til personskade. Før du utfører arbeid på utstyr, må du være oppmerksom på de faremomentene som elektriske kretser innebærer, samt gjøre deg kjent med vanlig praksis når det gjelder å unngå ulykker.

Aviso Este símbolo de aviso indica perigo. Encontra-se numa situação que lhe poderá causar danos físicos. Antes de começar a trabalhar com qualquer equipamento, familiarize-se com os perigos relacionados com circuitos eléctricos, e com quaisquer práticas comuns que possam prevenir possíveis acidentes.

¡Advertencia! Este símbolo de aviso significa peligro. Existe riesgo para su integridad física. Antes de manipular cualquier equipo, considerar los riesgos que entraña la corriente eléctrica y familiarizarse con los procedimientos estándar de prevención de accidentes.

Warning! Denna varningssymbol signalerar fara. Du befinner dig i en situation som kan leda till personskada. Innan du utför arbete på någon utrustning måste du vara medveten om farorna med elkretsar och känna till vanligt förfarande för att förebygga skador.

Power Disconnection Warning



Warning Before working on a system that has an on/off switch, turn off the power and unplug the power cord.

Waarschuwing Voordat u aan een systeem werkt dat een aan/uit schakelaar heeft, dient u de stroomvoorziening UIT te schakelen en de stekker van het netsnoer uit het stopcontact te halen.

Varoitus Ennen kuin teet mitään sellaiselle järjestelmälle, jossa on kaksiasentokytkin, katkaise siitä virta ja kytke virtajohto irti.

Attention Avant de travailler sur un système équipé d'un commutateur marche-arrêt, mettre l'appareil à l'arrêt (off) et débrancher le cordon d'alimentation.

Warnung Bevor Sie an einem System mit Ein/Aus-Schalter arbeiten, schalten Sie das System AUS und ziehen das Netzkabel aus der Steckdose.

Avvertenza Prima di lavorare su un sistema dotato di un interruttore on/off, spegnere (off) il sistema e staccare il cavo dell'alimentazione.

Advarsel Slå AV strømmen og trekk ut strømledningen før det utføres arbeid på et system som er utstyrt med en av/på-bryter.

Aviso Antes de começar a trabalhar num sistema que tem um interruptor on/off, DESLIGUE a corrente eléctrica e retire o cabo de alimentação da tomada.

¡Advertencia! Antes de utilizar cualquier sistema equipado con interruptor de Encendido/Apagado (on/off), cortar la alimentación y desenchufar el cable de alimentación.

Warning! Slå AV strømmen och dra ur nätsladden innan du utför arbete på ett system med strömbrytare.

Chassis Warning—Disconnecting Telephone-Network Cables



Warning Before opening the chassis, disconnect the telephone-network cables to avoid contact with telephone-network voltages.

Waarschuwing Voordat u het frame opent, dient u de verbinding met het telefoonnetwerk te verbreken door de kabels te ontkoppelen om zo contact met telefoonnetwerk-spanningen te vermijden.

Varoitus Vältä joutumista kosketuksiin puhelinverkostojännitteiden kanssa irrottamalla puhelinverkoston kaapelit ennen asennuspohjan aukaisemista.

Attention Avant d'ouvrir le châssis, débrancher les câbles du réseau téléphonique afin d'éviter tout contact avec les tensions d'alimentation du réseau téléphonique.

Warnung Bevor Sie das Chassis öffnen, ziehen Sie die Telefonnetzkabel aus der Verbindung, um Kontakt mit Telefonnetzspannungen zu vermeiden.

Avvertenza Prima di aprire il telaio, scollegare i cavi della rete telefonica per evitare di entrare in contatto con la tensione di rete.

Advarsel Før kabinettet åpnes, skal kablene for telenettet kobles fra for å unngå å komme i kontakt med spenningen i telenettet.

Aviso Antes de abrir o chassis, desligue os cabos da rede telefónica para evitar contacto com a tensão da respectiva rede.

¡Advertencia! Antes de abrir el chasis, desconectar el cableado dirigido a la red telefónica para evitar contacto con voltajes de la propia red.

Varning! Koppla loss ledningarna till telefonnätet innan du öppnar chassit så att kontakten med telefonnätsspänningen bryts.

Lightning Activity Warning



Warning Do not work on the system or connect or disconnect cables during periods of lightning activity.

Waarschuwing Tijdens onweer dat gevaar gaat met bliksem, dient u niet aan het systeem te werken of kabels aan te sluiten of te ontkoppelen.

Varoitus Älä työskentele järjestelmän parissa äläkä yhdistä tai irrota kaapeleita ukkosilmalla.

Attention Ne pas travailler sur le système ni brancher ou débrancher les câbles pendant un orage.

Warnung Arbeiten Sie nicht am System und schließen Sie keine Kabel an bzw. trennen Sie keine ab, wenn es gewittert.

Avvertenza Non lavorare sul sistema o collegare oppure scollegare i cavi durante un temporale con fulmini.

Advarsel Utfør aldri arbeid på systemet, eller koble kabler til eller fra systemet når det tordner eller lyner.

Aviso Não trabalhe no sistema ou ligue e desligue cabos durante períodos de mau tempo (trovoada).

¡Advertencia! No operar el sistema ni conectar o desconectar cables durante el transcurso de descargas eléctricas en la atmósfera.

Varning! Vid åska skall du aldrig utföra arbete på systemet eller ansluta eller koppla loss kablar.

Power Supply Warning



Warning Do not touch the power supply when the power cord is connected. For systems with a power switch, line voltages are present within the power supply even when the power switch is off and the power cord is connected. For systems without a power switch, line voltages are present within the power supply when the power cord is connected.

Waarschuwing U dient de voeding niet aan te raken zolang het netsnoer aangesloten is. Bij systemen met een stroomschakelaar zijn er lijnspanningen aanwezig in de voeding, zelfs wanneer de stroomschakelaar uitgeschakeld is en het netsnoer aangesloten is. Bij systemen zonder een stroomschakelaar zijn er lijnspanningen aanwezig in de voeding wanneer het netsnoer aangesloten is.

Varoitus Älä kosketa virtalähdettä virtajohdon ollessa kytkettynä. Virrankatkaisimella varustetuissa järjestelmissä on virtalähteen sisällä jäljellä verkkojännite, vaikka virrankatkaisin on katkaistu-asennossa virtajohdon ollessa kytkettynä. Järjestelmissä, joissa ei ole virrankatkaisinta, on virtalähteen sisällä verkkojännite, kun virtajohto on kytkettynä.

Attention Ne pas toucher le bloc d'alimentation quand le cordon d'alimentation est branché. Avec les systèmes munis d'un commutateur marche-arrêt, des tensions de ligne sont présentes dans l'alimentation quand le cordon est branché, même si le commutateur est à l'arrêt. Avec les systèmes sans commutateur marche-arrêt, l'alimentation est sous tension quand le cordon d'alimentation est branché.

Warnung Berühren Sie das Netzgerät nicht, wenn das Netzkabel angeschlossen ist. Bei Systemen mit Netzschalter liegen Leitungsspannungen im Netzgerät vor, wenn das Netzkabel angeschlossen ist, auch wenn das System ausgeschaltet ist. Bei Systemen ohne Netzschalter liegen Leitungsspannungen im Netzgerät vor, wenn das Netzkabel angeschlossen ist.

Avvertenza Non toccare l'alimentatore se il cavo dell'alimentazione è collegato. Per i sistemi con un interruttore di alimentazione, tensioni di linea sono presenti all'interno dell'alimentatore anche quando l'interruttore di alimentazione è in posizione di disattivazione (off), se il cavo dell'alimentazione è collegato. Per i sistemi senza un interruttore, tensioni di linea sono presenti all'interno dell'alimentatore quando il cavo di alimentazione è collegato.

Advarsel Berør ikke strømforsyningsenheden når strømledningen er tilkoblet. I systemer som har en strømbryter, er det spenning i strømforsyningsenheden selv om strømbryteren er slått av og strømledningen er tilkoblet. Når det gjelder systemer uten en strømbryter, er det spenning i strømforsyningsenheden når strømledningen er tilkoblet.

Aviso Não toque na unidade abastecedora de energia quando o cabo de alimentação estiver ligado. Em sistemas com interruptor, a corrente eléctrica estará presente na unidade abastecedora, sempre que o cabo de alimentação de energia estiver ligado, mesmo quando o interruptor se encontrar desligado. Para sistemas sem interruptor, a tensão eléctrica dentro da unidade abastecedora só estará presente quando o cabo de alimentação estiver ligado.

¡Advertencia! No tocar la fuente de alimentación mientras el cable esté enchufado. En sistemas con interruptor de alimentación, hay voltajes de línea dentro de la fuente, incluso cuando el interruptor esté en Apagado (off) y el cable de alimentación enchufado. En sistemas sin interruptor de alimentación, hay voltajes de línea en la fuente cuando el cable está enchufado.

Warning! Vidrör inte strömförsörjningsenheten när nätsladden är ansluten. För system med strömbrytare finns det nätspänning i strömförsörjningsenheten även när strömmen har slagits av men nätsladden är ansluten. För system utan strömbrytare finns det nätspänning i strömförsörjningsenheten när nätsladden är ansluten.

DC Power Supply Warning



Warning When stranded wiring is required, use approved wiring terminations, such as closed-loop or spade-type with upturned lugs. These terminations should be the appropriate size for the wires and should clamp both the insulation and conductor.

Waarschuwing Wanneer geslagen bedrading vereist is, dient u bedrading te gebruiken die voorzien is van goedgekeurde aansluitingspunten, zoals het gesloten-lus type of het grijperschop type waarbij de aansluitpunten omhoog wijzen. Deze aansluitpunten dienen de juiste maat voor de draden te hebben en dienen zowel de isolatie als de geleider vast te klemmen.

Varoitus Jos säikeellinen johdin on tarpeen, käytä hyväksytyä johdinliitääntä, esimerkiksi suljettua silmukkaa tai kourumaista liitääntä, jossa on ylöspäin käännetyt kiinnityskorvat. Tällaisten liitääntöjen tulee olla kooltaan johtimiin sopivia ja niiden tulee puristaa yhteen sekä eristeen että johdinosan.

Attention Quand des fils torsadés sont nécessaires, utiliser des douilles terminales homologuées telles que celles à circuit fermé ou du type à plage ouverte avec cosses rebroussées. Ces douilles terminales doivent être de la taille qui convient aux fils et doivent être refermées sur la gaine isolante et sur le conducteur.

Warnung Wenn Litzenverdrahtung erforderlich ist, sind zugelassene Verdrahtungsabschlüsse, z.B. für einen geschlossenen Regelkreis oder gabelförmig, mit nach oben gerichteten Kabelschuhen zu verwenden. Diese Abschlüsse sollten die angemessene Größe für die Drähte haben und sowohl die Isolierung als auch den Leiter festklemmen.

Avvertenza Quando occorre usare trecce, usare connettori omologati, come quelli a occhio o a forcilla con linguette rivolte verso l'alto. I connettori devono avere la misura adatta per il cablaggio e devono serrare sia l'isolante che il conduttore.

Advarsel Hvis det er nødvendig med flertrådede ledninger, brukes godkjente ledningsavslutninger, som for eksempel lukket sløyfe eller spadetype med oppoverbøyde kabelsko. Disse avslutningene skal ha riktig størrelse i forhold til ledningene, og skal klemme sammen både isolasjonen og ledaren.

Aviso Quando forem requeridas montagens de instalação eléctrica de cabo torcido, use terminações de cabo aprovadas, tais como, terminações de cabo em circuito fechado e planas com terminais de orelha voltados para cima. Estas terminações de cabo deverão ser do tamanho apropriado para os respectivos cabos, e deverão prender simultaneamente o isolamento e o fio condutor.

¡Advertencia! Cuando se necesite hilo trenzado, utilizar terminales para cables homologados, tales como las de tipo "bucle cerrado" o "espada", con las lengüetas de conexión vueltas hacia arriba. Estos terminales deberán ser del tamaño apropiado para los cables que se utilicen, y tendrán que sujetar tanto el aislante como el conductor.

Warning! När flertrådiga ledningar krävs måste godkända ledningskontakter användas, t.ex. kabelsko av sluten eller öppen typ med uppåtvänd tapp. Storleken på dessa kontakter måste vara avpassad till ledningarna och måste kunna hålla både isoleringen och ledaren fastklämda.

DC Power Disconnection Warning



Warning Before performing any of the following procedures, ensure that power is removed from the DC circuit. To ensure that all power is off, locate the circuit breaker on the panel board that services the DC circuit, switch the circuit breaker to the off position, and tape the switch handle of the circuit breaker in the off position.

Waarschuwing Voordat u een van de onderstaande procedures uitvoert, dient u te controleren of de stroom naar het gelijkstroom circuit uitgeschakeld is. Om u ervan te verzekeren dat alle stroom UIT is geschakeld, kiest u op het schakelbord de stroomverbreker die het gelijkstroom circuit bedient, draait de stroomverbreker naar de UIT positie en plakt de schakelaarhendel van de stroomverbreker met plakband in de UIT positie vast.

Varoitus Varmista, että tasavirtapiirissä ei ole virtaa ennen seuraavien toimenpiteiden suorittamista. Varmistaaksesi, että virta on KATKAISTU täysin, paikanna tasavirrasta huolehtivassa kojetaulussa sijaitseva suojakytkin, käännä suojakytkin KATKAISTU-asentoon ja teippaa suojakytkimen varsi niin, että se pysyy KATKAISTU-asennossa.

Attention Avant de pratiquer l'une quelconque des procédures ci-dessous, vérifiez que le circuit en courant continu n'est plus sous tension. Pour en être sûr, localiser le disjoncteur situé sur le panneau de service du circuit en courant continu, placer le disjoncteur en position fermée (off) et, à l'aide d'un ruban adhésif, bloquer la poignée du disjoncteur en position off.

Warnung Vor Ausführung der folgenden Vorgänge ist sicherzustellen, daß die Gleichstromschaltung keinen Strom erhält. Um sicherzustellen, daß sämtlicher Strom abgestellt ist, machen Sie auf der Schalttafel den Unterbrecher für die Gleichstromschaltung ausfindig, stellen Sie den Unterbrecher auf AUS, und kleben Sie den Schaltergriff des Unterbrechers mit Klebeband in der AUS-Stellung fest.

Avvertenza Prima di svolgere una qualsiasi delle procedure seguenti, verificare che il circuito CC non sia alimentato. Per verificare che tutta l'alimentazione sia scollegata (OFF), individuare l'interruttore automatico sul quadro strumenti che alimenta il circuito CC, mettere l'interruttore in posizione off e fissarlo con nastro adesivo in tale posizione.

Advarsel Før noen av disse prosedyrene utføres, kontroller at strømmen er frakoblet likestrømkretsen. Sørg for at all strøm er slått AV. Dette gjøres ved å lokalisere strømbryteren på brytertavlen som betjener likestrømkretsen, slå strømbryteren AV og teipe bryterhåndtaket på strømbryteren i AV-stilling.

Aviso Antes de executar um dos seguintes procedimentos, certifique-se que desligou a fonte de alimentação de energia do circuito de corrente contínua. Para se assegurar que toda a corrente foi DESLIGADA, localize o disjuntor no painel que serve o circuito de corrente contínua e coloque-o na posição off (Desligado), segurando nessa posição a manivela do interruptor do disjuntor com fita isoladora.

¡Advertencia! Antes de proceder con los siguientes pasos, comprobar que la alimentación del circuito de corriente continua (CC) esté cortada (off). Para asegurarse de que toda la alimentación esté cortada (off), localizar el interruptor automático en el panel que alimenta al circuito de corriente continua, cambiar el interruptor automático a la posición de Apagado (off), y sujetar con cinta la palanca del interruptor automático en posición de Apagado (off).

Warning! Innan du utför någon av följande procedurer måste du kontrollera att strömförsörjningen till likströmskretsen är bruten. Kontrollera att all strömförsörjning är BRUTEN genom att slå AV det överspänningsskydd som skyddar likströmskretsen och teipa fast överspänningsskyddets omkopplare i FRÅN-läget.

DC Power Connection Warning



Warning After wiring the DC power supply, remove the tape from the circuit breaker switch handle and reinstate power by moving the handle of the circuit breaker to the on position.

Waarschuwing Nadat de bedrading van de gelijkstroom voeding aangebracht is, verwijderd u het plakband van de schakelaarhendel van de stroomverbreker en schakelt de stroom weer in door de hendel van de stroomverbreker naar de AAN positie te draaien.

Varoitus Yhdistettyäsi tasavirtalähteen johdon avulla poista teippi suojakytkimen varresta ja kytke virta uudestaan kääntämällä suojakytkimen varsi KYTKETTY-asentoon.

Attention Une fois l'alimentation connectée, retirer le ruban adhésif servant à bloquer la poignée du disjoncteur et rétablir l'alimentation en plaçant cette poignée en position de marche (on).

Warnung Nach Verdrahtung des Gleichstrom-Netzgeräts entfernen Sie das Klebeband vom Schaltergriff des Unterbrechers und schalten den Strom erneut ein, indem Sie den Griff des Unterbrechers auf EIN stellen.

Avvertenza Dopo aver eseguito il cablaggio dell'alimentatore CC, togliere il nastro adesivo dall'interruttore automatico e ristabilire l'alimentazione spostando all'interruttore automatico in posizione on.

Advarsel Etter at likestrømsenheten er tilkoblet, fjernes teipen fra håndtaket på strømbryteren, og deretter aktiveres strømmen ved å dreie håndtaket på strømbryteren til PÅ-stilling.

Aviso Depois de ligar o sistema de fornecimento de corrente contínua, retire a fita isoladora da manivela do disjuntor, e volte a ligar a corrente ao deslocar a manivela para a posição on (Ligado).

¡Advertencia! Después de cablear la fuente de alimentación de corriente continua, retirar la cinta de la palanca del interruptor automático, y restablecer la alimentación cambiando la palanca a la posición de Encendido (on).

Warning! När du har kopplat ledningarna till strömförsörjningsenheten för inmatad likström tar du bort teipen från överspänningsskyddets omkopplare och slår på strømmen igen genom att ställa överspänningsskyddets omkopplare i TILL-läget.

DC Power Supply Wiring Warning



Warning The illustration shows the DC power supply terminal block. Wire the DC power supply using the appropriate lugs at the wiring end, as illustrated. The proper wiring sequence is ground to ground, positive to positive (line to L), and negative to negative (neutral to N). Note that the ground wire should always be connected first and disconnected last.

Waarschuwing De figuur toont de aansluitstrip van de gelijkstroomvoeding. Breng de bedrading aan voor de gelijkstroomvoeding met behulp van de juiste aansluitpunten aan het draadeinde zoals aangegeven. De juiste bedradingsvolgorde is aarde naar aarde, positief naar positief (lijn naar L) en negatief naar negatief (neutraal naar N). Let op dat de aarddraad altijd het eerst verbonden en het laatst losgemaakt wordt.

Varoitus Kuva esittää tasavirran pääterasiasa. Liitä tasavirtalähde johdon avulla käyttäen sopivia kiinnityskorvia johdon päässä kuvan esittämällä tavalla. Oikea kytkenjärjestys on maajohto maajohtoon, positiivinen positiiviseen (johto L:ään) ja negatiivinen negatiiviseen (nollajohto N:ään). Ota huomioon, että maajohto on aina yhdistettävä ensin ja irrotettava viimeisenä.

Attention La figure illustre le bloc de connexion de l'alimentation en courant continu. Câbler l'alimentation en courant continu en fixant les cosses qui conviennent aux extrémités câblées conformément au schéma. La séquence de câblage à suivre est terre-terre, positif-positif (ligne sur L), et négatif-négatif (neutre sur N). Noter que le fil de masse doit toujours être connecté en premier et déconnecté en dernier.

Warnung Die Abbildung zeigt den Terminalblock des Gleichstrom-Netzgeräts. Verdrahten Sie das Gleichstrom-Netzgerät unter Verwendung von geeigneten Kabelschuhen am Verdrahtungsende (siehe Abbildung). Die richtige Verdrahtungsfolge ist Erde an Erde, positiv an positiv (Leitung an L) und negativ an negativ (neutral an N). Beachten Sie bitte, daß der Erdungsdraht immer als erster verbunden und als letzter abgetrennt werden sollte.

Avvertenza L'illustrazione mostra la morsettiere dell'alimentatore CC. Cablare l'alimentatore CC usando i connettori adatti all'estremità del cablaggio, come illustrato. La corretta sequenza di cablaggio è da massa a massa, da positivo a positivo (da linea ad L) e da negativo a negativo (da neutro a N). Tenere presente che il filo di massa deve sempre venire collegato per primo e scollegato per ultimo.

Advarsel Figuren viser likestrømforsyningsenhetens tilkoplingsterminal. Likestrømforsyningsenheten tilkoples ved hjelp av passende kabelsko som festes i enden av ledningene, slik som vist i figuren. Riktig tilkoplingssekvens er jord til jord, positiv til positiv (linje til L), og negativ til negativ (nøytral til N). Husk at jordingsledningen alltid bør tilkoples først og frakoples sist.

Aviso A figura mostra o bloco do terminal de fornecimento de corrente contínua. Ligue o fornecimento de corrente contínua utilizando as extremidades apropriadas no final do cabo, conforme ilustrado. A sequência correcta de instalação é terra-a-terra, positivo-positivo (linha para L), e negativo-negativo (neutro para N). Note que o fio de terra deverá ser sempre o primeiro a ser ligado, e o último a ser desligado.

¡Advertencia! La figura muestra la caja de bornes de la fuente de alimentación. Cablear la fuente de alimentación de corriente continua, usando las lengüetas de conexión apropiadas, en el extremo del cable tal como se muestra. Las conexiones deben realizarse en el siguiente orden: tierra con tierra, positivo con positivo (la línea con la L) y negativo con negativo (el neutro con la N). Tenga en cuenta que el conductor de tierra siempre tiene que conectarse el primero y desconectarse el último.

Varning! Illustrationen visar anslutningsplinten för likströmförsörjningsenheten. Koppla ledningarna till strömförsörjningsenheten med lämpliga kabelskor i ledningsändarna som bilden visar. Korrekt kopplingssekvens är jord till jord, positiv till positiv (linje till L) och negativ till negativ (neutral till N). Observera att jordledningen alltid skall anslutas först och kopplas bort sist.

Installation Warning 1



Warning Read the installation instructions before you connect the system to its power source.

Waarschuwing Raadpleeg de installatie-aanwijzingen voordat u het systeem met de voeding verbindt.

Varoitus Lue asennusohjeet ennen järjestelmän yhdistämistä virtalähteeseen.

Attention Avant de brancher le système sur la source d'alimentation, consulter les directives d'installation.

Warnung Lesen Sie die Installationsanweisungen, bevor Sie das System an die Stromquelle anschließen.

Avvertenza Consultare le istruzioni di installazione prima di collegare il sistema all'alimentatore.

Advarsel Les installasjonsinstruksjonene før systemet kobles til strømkilden.

Aviso Leia as instruções de instalação antes de ligar o sistema à sua fonte de energia.

¡Advertencia! Ver las instrucciones de instalación antes de conectar el sistema a la red de alimentación.

Warning! Läs installationsanvisningarna innan du kopplar systemet till dess strömförsörjningsenhet.

Installation Warning 2



Warning Only trained and qualified personnel should be allowed to install, replace, or service this equipment.

Waarschuwing Deze apparatuur mag alleen worden geïnstalleerd, vervangen of hersteld door bevoegd geschoold personeel.

Varoitus Tämän laitteen saa asentaa, vaihtaa tai huoltaa ainoastaan koulutettu ja laitteen tunteva henkilökunta.

Attention Il est vivement recommandé de confier l'installation, le remplacement et la maintenance de ces équipements à des personnels qualifiés et expérimentés.

Warnung Das Installieren, Ersetzen oder Bedienen dieser Ausrüstung sollte nur geschultem, qualifiziertem Personal gestattet werden.

Avvertenza Questo apparato può essere installato, sostituito o mantenuto unicamente da un personale competente.

Advarsel Bare opplært og kvalifisert personell skal foreta installasjoner, utskiftninger eller service på dette utstyret.

Aviso Apenas pessoal treinado e qualificado deve ser autorizado a instalar, substituir ou fazer a revisão deste equipamento.

¡Advertencia! Solamente el personal calificado debe instalar, reemplazar o utilizar este equipo.

Warning! Endast utbildad och kvalificerad personal bör få tillåtelse att installera, byta ut eller reparera denna utrustning.

Incorrect Connection Warning



Warning Incorrect connection of this or connected equipment to a general purpose outlet could result in a hazardous situation.

Waarschuwing Incorrecte aansluiting van deze of aangesloten apparatuur op een stopcontact voor algemene doeleinden kan een gevaarlijke situatie tot gevolg hebben.

Varoitus Tämän laitteen tai siihen liitettyjen laitteiden virheellinen kytkentä yleispistorasiaan voi aiheuttaa vaaratilanteen.

Attention Un branchement incorrect de cet équipement ou de l'équipement branché à une prise d'usage général peut créer une situation dangereuse.

Warnung Inkorrektes Anschließen von diesem oder damit verbundenen Geräten an einer Allzwecksteckdose kann eine Gefahrensituation verursachen.

Avvertenza Un collegamento errato di questo apparecchio, o dell'apparecchiatura a esso collegato, a una presa di uso generale può causare una situazione pericolosa.

Advarsel Feil kobling av dette utstyret eller tilhørende utstyr til et vanlig uttak kan føre til farlige situasjoner.

Aviso Uma conexão incorrecta a uma ficha de alimentação eléctrica normal, deste ou de qualquer equipamento a este conectado, poderá resultar numa situação potencialmente perigosa.

Advertencia La conexión incorrecta de este equipo, o del equipo conectado, a una toma o receptáculo de tipo general podría resultar en una situación peligrosa.

Warning! Felaktig koppling av denna eller ansluten utrustning till ett universaluttak kan orsaka riskfylld situation.

Power Supply Disconnection Warning



Warning Before working on a chassis or working near power supplies, unplug the power cord on AC units; disconnect the power at the circuit breaker on DC units.

Waarschuwing Voordat u aan een frame of in de nabijheid van voedingen werkt, dient u bij wisselstroom toestellen de stekker van het netsnoer uit het stopcontact te halen; voor gelijkstroom toestellen dient u de stroom uit te schakelen bij de stroomverbreker.

Varoitus Kytke irti vaihtovirtalaitteiden virtajohto ja katkaise tasavirtalaitteiden virta suojakytkimellä, ennen kuin teet mitään asennuspohjalle tai työskentelet virtalähteiden läheisyydessä.

Attention Avant de travailler sur un châssis ou à proximité d'une alimentation électrique, débrancher le cordon d'alimentation des unités en courant alternatif ; couper l'alimentation des unités en courant continu au niveau du disjoncteur.

Warnung Bevor Sie an einem Chassis oder in der Nähe von Netzgeräten arbeiten, ziehen Sie bei Wechselstromeinheiten das Netzkabel ab bzw. schalten Sie bei Gleichstromeinheiten den Strom am Unterbrecher ab.

Avvertenza Prima di lavorare su un telaio o intorno ad alimentatori, scollegare il cavo di alimentazione sulle unità CA; scollegare l'alimentazione all'interruttore automatico sulle unità CC.

Advarsel Før det utføres arbeid på kabinettet eller det arbeides i nærheten av strømforsyningsenheter, skal strømfedningen trekkes ut på AC-vekselstrømsenheter og strømmen kobles fra ved strømbryteren på likestrømsenheter.

Aviso Antes de trabalhar num chassis, ou antes de trabalhar perto de unidades de fornecimento de energia, desligue o cabo de alimentação nas unidades de corrente alternada; desligue a corrente no disjuntor nas unidades de corrente contínua.

¡Advertencia! Antes de manipular el chasis de un equipo o trabajar cerca de una fuente de alimentación, desenchufar el cable de alimentación en los equipos de corriente alterna (CA); cortar la alimentación desde el interruptor automático en los equipos de corriente continua (CC).

Warning! Innan du arbetar med ett chassi eller nära strömförsörjningsenheter skall du för växelströmsenheter dra ur nätsladden och för likströmsenheter bryta strömmen vid överspänningsskyddet.

Circuit Breaker (15A) Warning



Warning This product relies on the building's installation for short-circuit (overcurrent) protection. Ensure that a fuse or circuit breaker no larger than 120 VAC, 15A U.S. (240 VAC, 10A international) is used on the phase conductors (all current-carrying conductors).

Waarschuwing Dit produkt is afhankelijk van de installatie van het gebouw voor kortsluit-(overstroom)beveiliging. Controleer of er een zekering of stroomverbreker van niet meer dan 120 Volt wisselstroom, 15 A voor de V.S. (240 Volt wisselstroom, 10 A internationaal) gebruikt wordt op de fasegeleiders (alle geleiders die stroom voeren).

Varoitus Tämä tuote on riippuvainen rakennukseen asennetusta oikosulkusuojauksesta (ylivirtasuojauksesta). Varmista, että vaihevirtajohtimissa (kaikissa virroitetuissa johtimissa) käytetään Yhdysvalloissa alle 120 voltin, 15 ampeerin ja monissa muissa maissa 240 voltin, 10 ampeerin sulaketta tai suojakytkintä.

Attention Pour ce qui est de la protection contre les courts-circuits (surtension), ce produit dépend de l'installation électrique du local. Vérifier qu'un fusible ou qu'un disjoncteur de 120 V alt., 15 A U.S. maximum (240 V alt., 10 A international) est utilisé sur les conducteurs de phase (conducteurs de charge).

Warnung Dieses Produkt ist darauf angewiesen, daß im Gebäude ein Kurzschluß- bzw. Überstromschutz installiert ist. Stellen Sie sicher, daß eine Sicherung oder ein Unterbrecher von nicht mehr als 240 V Wechselstrom, 10 A (bzw. in den USA 120 V Wechselstrom, 15 A) an den Phasenleitern (allen stromführenden Leitern) verwendet wird.

Avvertenza Questo prodotto dipende dall'installazione dell'edificio per quanto riguarda la protezione contro cortocircuiti (sovracorrente). Verificare che un fusibile o interruttore automatico, non superiore a 120 VCA, 15 A U.S. (240 VCA, 10 A internazionale) sia stato usato nei fili di fase (tutti i conduttori portatori di corrente).

Advarsel Dette produktet er avhengig av bygningens installasjoner av kortslutningsbeskyttelse (overstrøm). Kontroller at det brukes en sikring eller strømbryter som ikke er større enn 120 VAC, 15 A (USA) (240 VAC, 10 A internasjonalt) på faselederne (alle strømførende ledere).

Aviso Este produto depende das instalações existentes para protecção contra curto-circuito (sobrecarga). Assegure-se de que um fusível ou disjuntor não superior a 240 VAC, 10A é utilizado nos condutores de fase (todos os condutores de transporte de corrente).

¡Advertencia! Este equipo utiliza el sistema de protección contra cortocircuitos (o sobrecorrientes) del propio edificio. Asegurarse de que se utiliza un fusible o interruptor automático de no más de 240 voltios en corriente alterna (VAC), 10 amperios del estándar internacional (120 VAC, 15 amperios del estándar USA) en los hilos de fase (todos aquellos portadores de corriente).

Warning! Denna produkt är beroende av i byggnaden installerat kortslutningsskydd (överströmsskydd). Kontrollera att säkring eller överspänningsskydd används på fasledarna (samtliga strömförande ledare) ¥ för internationellt bruk max. 240 V växelström, 10 A (i USA max. 120 V växelström, 15 A).

Electric Shock Warning



Warning This unit might have more than one power cord. To reduce the risk of electric shock, disconnect the two power supply cords before servicing the unit.

Waarschuwing Dit toestel kan meer dan één netsnoer hebben. Om het risico van een elektrische schok te verminderen, dient u de stekkers van de twee netsnoeren uit het stopcontact te halen voordat u het toestel een servicebeurt geeft.

Varoitus Tässä laitteessa saattaa olla useampi kuin yksi virtajohto. Irrota molemmat virtalähteestä tulevat johtimet ennen laitteen huoltamista, jotta vältät sähköiskun vaaran.

Attention Il est possible que cette unité soit munie de plusieurs cordons d'alimentation. Pour éviter les risques d'électrocution, débrancher les deux cordons d'alimentation avant de réparer l'unité.

Warnung Diese Einheit hat möglicherweise mehr als ein Netzkabel. Zur Verringerung der Stromschlaggefahr trennen Sie beide Netzgerätekabel ab, bevor Sie die Einheit warten.

Avvertenza Questa unità potrebbe essere dotata di più di un cavo di alimentazione. Per ridurre il rischio di scossa elettrica, scollegare i due cavi di alimentazione prima di procedere alla manutenzione dell'unità.

Advarsel Denne enheten kan være utstyrt med mer enn én strømledning. Koble fra de to strømledningene før det utføres reparasjonsarbeid på enheten for å redusere faren for elektriske støt.

Aviso Esta unidade poderá ter mais do que um cabo de alimentação. Para reduzir o risco de choque eléctrico, desligue os dois cabos de alimentação antes de efectuar reparações na unidade.

¡Advertencia! Puede ser que este equipo posea más de un cable de alimentación. Para reducir el riesgo de descarga eléctrica, desenchufar los dos cables antes de proceder al mantenimiento de la unidad.

Warning! Denna enhet kan vara försedd med mer än en nätsladd. För att minska risken för elektriska stötar skall båda nätsladdarna dras ur innan du utför underhållsarbete på enheten.

Chassis Warning—Rack-Mounting and Servicing



Warning To prevent bodily injury when mounting or servicing this unit in a rack, you must take special precautions to ensure that the system remains stable. The following guidelines are provided to ensure your safety:

- This unit should be mounted at the bottom of the rack if it is the only unit in the rack.
- When mounting this unit in a partially filled rack, load the rack from the bottom to the top with the heaviest component at the bottom of the rack.
- If the rack is provided with stabilizing devices, install the stabilizers before mounting or servicing the unit in the rack.

Waarschuwing Om lichamelijk letsel te voorkomen wanneer u dit toestel in een rek monteert of het daar een servicebeurt geeft, moet u speciale voorzorgsmaatregelen nemen om ervoor te zorgen dat het toestel stabiel blijft. De onderstaande richtlijnen worden verstrekt om uw veiligheid te verzekeren:

- Dit toestel dient onderaan in het rek gemonteerd te worden als het toestel het enige in het rek is.
- Wanneer u dit toestel in een gedeeltelijk gevuld rek monteert, dient u het rek van onderen naar boven te laden met het zwaarste onderdeel onderaan in het rek.
- Als het rek voorzien is van stabiliseringshulpmiddelen, dient u de stabilisatoren te monteren voordat u het toestel in het rek monteert of het daar een servicebeurt geeft.

Varoitus Kun laite asetetaan telineeseen tai huolletaan sen ollessa telineessä, on noudatettava erityisiä varotoimia järjestelmän vakavuuden säilyttämiseksi, jotta vältetään loukkaantumiselta. Noudata seuraavia turvallisuusohjeita:

- Jos telineessä ei ole muita laitteita, aseta laite telineen alaosaan.
- Jos laite asetetaan osaksi täytettyyn telineeseen, aloita kuormittaminen sen alaosasta kaikkein raskaimmalla esineellä ja siirry sitten sen yläosaan.
- Jos telinettä varten on vakaimet, asenna ne ennen laitteen asettamista telineeseen tai sen huoltamista siinä.

Attention Pour éviter toute blessure corporelle pendant les opérations de montage ou de réparation de cette unité en casier, il convient de prendre des précautions spéciales afin de maintenir la stabilité du système. Les directives ci-dessous sont destinées à assurer la protection du personnel :

- Si cette unité constitue la seule unité montée en casier, elle doit être placée dans le bas.
- Si cette unité est montée dans un casier partiellement rempli, charger le casier de bas en haut en plaçant l'élément le plus lourd dans le bas.
- Si le casier est équipé de dispositifs stabilisateurs, installer les stabilisateurs avant de monter ou de réparer l'unité en casier.

Warnung Zur Vermeidung von Körperverletzung beim Anbringen oder Warten dieser Einheit in einem Gestell müssen Sie besondere Vorkehrungen treffen, um sicherzustellen, daß das System stabil bleibt. Die folgenden Richtlinien sollen zur Gewährleistung Ihrer Sicherheit dienen:

- Wenn diese Einheit die einzige im Gestell ist, sollte sie unten im Gestell angebracht werden.
- Bei Anbringung dieser Einheit in einem zum Teil gefüllten Gestell ist das Gestell von unten nach oben zu laden, wobei das schwerste Bauteil unten im Gestell anzubringen ist.
- Wird das Gestell mit Stabilisierungszubehör geliefert, sind zuerst die Stabilisatoren zu installieren, bevor Sie die Einheit im Gestell anbringen oder sie warten.

Avvertenza Per evitare infortuni fisici durante il montaggio o la manutenzione di questa unità in un supporto, occorre osservare speciali precauzioni per garantire che il sistema rimanga stabile. Le seguenti direttive vengono fornite per garantire la sicurezza personale:

- Questa unità deve venire montata sul fondo del supporto, se si tratta dell'unica unità da montare nel supporto.
- Quando questa unità viene montata in un supporto parzialmente pieno, caricare il supporto dal basso all'alto, con il componente più pesante sistemato sul fondo del supporto.
- Se il supporto è dotato di dispositivi stabilizzanti, installare tali dispositivi prima di montare o di procedere alla manutenzione dell'unità nel supporto.

Advarsel Unngå fysiske skader under montering eller reparasjonsarbeid på denne enheten når den befinner seg i et kabinett. Vær nøye med at systemet er stabilt. Følgende retningslinjer er gitt for å verne om sikkerheten:

- Denne enheten bør monteres nederst i kabinettet hvis dette er den eneste enheten i kabinettet.
- Ved montering av denne enheten i et kabinett som er delvis fylt, skal kabinettet lastes fra bunnen og opp med den tyngste komponenten nederst i kabinettet.
- Hvis kabinettet er utstyrt med stabiliseringsutstyr, skal stabilisatorene installeres før montering eller utføring av reparasjonsarbeid på enheten i kabinettet.

Aviso Para se prevenir contra danos corporais ao montar ou reparar esta unidade numa estante, deverá tomar precauções especiais para se certificar de que o sistema possui um suporte estável. As seguintes directrizes ajudá-lo-ão a efectuar o seu trabalho com segurança:

- Esta unidade deverá ser montada na parte inferior da estante, caso seja esta a única unidade a ser montada.
- Ao montar esta unidade numa estante parcialmente ocupada, coloque os itens mais pesados na parte inferior da estante, arrumando-os de baixo para cima.
- Se a estante possuir um dispositivo de estabilização, instale-o antes de montar ou reparar a unidade.

¡Advertencia! Para evitar lesiones durante el montaje de este equipo sobre un bastidor, o posteriormente durante su mantenimiento, se debe poner mucho cuidado en que el sistema quede bien estable. Para garantizar su seguridad, proceda según las siguientes instrucciones:

- Colocar el equipo en la parte inferior del bastidor, cuando sea la única unidad en el mismo.
- Cuando este equipo se vaya a instalar en un bastidor parcialmente ocupado, comenzar la instalación desde la parte inferior hacia la superior colocando el equipo más pesado en la parte inferior.
- Si el bastidor dispone de dispositivos estabilizadores, instalar éstos antes de montar o proceder al mantenimiento del equipo instalado en el bastidor.

Warning! För att undvika kroppsskada när du installerar eller utför underhållsarbete på denna enhet på en ställning måste du vidta särskilda försiktighetsåtgärder för att försäkra dig om att systemet står stadigt. Följande riktlinjer ges för att trygga din säkerhet:

- Om denna enhet är den enda enheten på ställningen skall den installeras längst ned på ställningen.
- Om denna enhet installeras på en delvis fylld ställning skall ställningen fyllas nedifrån och upp, med de tyngsta enheterna längst ned på ställningen.
- Om ställningen är försedd med stabiliseringsdon skall dessa monteras fast innan enheten installeras eller underhålls på ställningen.

Overtemperature Warning



Warning To prevent the switch from overheating, do not operate it in an area that exceeds the maximum recommended ambient temperature of 104 F (40 C). To prevent airflow restriction, allow at least 3 inches (7.6 cm) of clearance around the ventilation openings.

Waarschuwing Om oververhitting van de schakelaar te voorkomen, mag u die niet bedienen in een ruimte die de maximale aanbevolen omgevingstemperatuur van 104 F (40 C) overschrijdt. Om beperking van de luchtstroom te voorkomen, dient u ten minste 3 inch (7,6 cm) speling te laten rondom de ventilatie-openingen.

Varoitus Estääksesi kytkimen ylikuumentumisen älä käytä sitä sellaisissa paikoissa, joiden lämpötila ylittää ympäristön enimmäislämpötilaksi suositellun 40 °C. Jätä vähintään 7,6 cm:n vapaa tila tuuletusaukkojen ympärille, jotta ilma pääsee vapaasti virtaamaan.

Attention Pour éviter une surchauffe du commutateur, ne pas le faire fonctionner dans un local dont la température ambiante dépasse le maximum recommandé de 40 °C (104 °F). Pour faciliter la circulation d'air, aménager un dégagement d'au moins 7,6 cm (3 pouces) autour des bouches d'aération.

Warnung Um eine Überhitzung des Schalters zu vermeiden, ist das System nicht in einem Bereich zu betreiben, in dem die empfohlene Höchsttemperatur von 40 °C überschritten wird. Damit der Luftfluß nicht behindert wird, ist ein Freiraum von mindestens 7,6 cm um die Belüftungsöffnungen herum einzuhalten.

Avvertenza Per evitare il surriscaldamento dell'interruttore, non usare l'apparecchiatura in un'area che supera la temperatura ambientale minima consigliata di 40 °C. Per evitare una limitazione del flusso dell'aria, lasciare come minimo uno spazio libero di 7,6 cm intorno alle aperture di ventilazione.

Advarsel For å unngå at bryteren overopphetes skal utstyret ikke brukes på steder hvor anbefalt maks omgivelsestemperatur overstiger 104 grader Fahrenheit (40 °C). La det være minst 3 tommer (7,6 cm) klaring rundt ventilasjonsåpningene for at luftsirkulasjonen skal være uhindret.

Aviso Para evitar sobreaquecimento do interruptor, não utilize o equipamento numa área que exceda uma temperatura máxima de 40 °C. Para evitar o bloqueamento da circulação de ar, deixe pelo menos um espaço de 7.6 cm em volta das aberturas de ventilação.

¡Advertencia! Para evitar que el interruptor se recaliente, no se debe usar en áreas cuya temperatura ambiente exceda la máxima recomendada, esto es, 40 °C (104 °F). Para no entorpecer la corriente de aire, dejar por lo menos 7,6 cm (3 pulgadas) de espacio muerto alrededor de la rejilla de ventilación.

Warning! För att undvika överhettning av strömbrytaren skall den inte användas i utrymme vars temperatur överskrider den maximalt rekommenderade omgivningstemperaturen 40 °C. Kontrollera att det finns minst 7,6 cm fritt utrymme runt ventilationsöppningarna så att luftflödet inte begränsas.

TN Power Warning



Warning The device is designed to work with TN power systems.

Waarschuwing Het apparaat is ontworpen om te functioneren met TN energiesystemen.

Varoitus Koje on suunniteltu toimimaan TN-sähkövoimajärjestelmien yhteydessä.

Attention Ce dispositif a été conçu pour fonctionner avec des systèmes d'alimentation TN.

Warnung Das Gerät ist für die Verwendung mit TN-Stromsystemen ausgelegt.

Avvertenza Il dispositivo è stato progettato per l'uso con sistemi di alimentazione TN.

Advarsel Utstyret er utfomet til bruk med TN-strømssystemer.

Aviso O dispositivo foi criado para operar com sistemas de corrente TN.

¡Advertencia! El equipo está diseñado para trabajar con sistemas de alimentación tipo TN.

Warning! Enheten är konstruerad för användning tillsammans med elkraftssystem av TN-typ.

SELV Circuit Warning



Warning The ports labeled "Ethernet," "10BaseT," "Token Ring," "Console," and "AUX" are safety extra-low voltage (SELV) circuits. SELV circuits should only be connected to other SELV circuits.

Waarschuwing De poorten die "Ethernet", "10BaseT", "Token Ring", "Console" en "AUX" zijn gelabeld, zijn veiligheidscircuits met extra lage spanning (genaamd SELV = safety extra-low voltage). SELV-circuits mogen alleen met andere SELV-circuits verbonden worden.

Varoitus Portit, joissa on nimet "Ethernet", "10BaseT", "Token Ring", "Console" ja "AUX", ovat erityisen pienen jännityksen omaavia turvallisuuspäirejä (SELV-päirejä). Tällaiset SELV-päirit tulee yhdistää ainoastaan muihin SELV-päireihin.

Attention Les ports étiquetés « Ethernet », « 10BaseT », « Token Ring », « Console » et « AUX » sont des circuits de sécurité basse tension (safety extra-low voltage ou SELV). Les circuits SELV ne doivent être interconnectés qu'avec d'autres circuits SELV.

Warnung Die mit "Ethernet", "10BaseT", "Token Ring", "Console" und "AUX" beschrifteten Buchsen sind Sicherheitskreise mit Sicherheitskleinspannung (safety extra-low voltage, SELV). SELV-Kreise sollten ausschließlich an andere SELV-Kreise angeschlossen werden.

Avvertenza Le porte contrassegnate da "Ethernet", "10BaseT", "TokenRing", "Console" e "AUX" sono circuiti di sicurezza con tensione molto bassa (SELV). I circuiti SELV devono essere collegati solo ad altri circuiti SELV.

Advarsel Utgangene merket "Ethernet", "10BaseT", "Token Ring", "Console" og "AUX" er lavspenning (SELV) for ekstra sikkerhet. SELV-kretser skal kun kobles til andre SELV-kretser.

Aviso As portas "Ethernet", "10BaseT", "Token Ring", "Console", and "AUX" são circuitos de segurança de baixa tensão (SELV). Estes circuitos deverão ser apenas ligados a outros circuitos SELV.

¡Advertencia! Los puertos "Ethernet", "10BaseT", "Token Ring", "Console" y "AUX" son circuitos de muy baja señal que garantizan ausencia de peligro (safety extra-low voltage = SELV). Estos circuitos SELV deben ser conectados exclusivamente con otros también de tipo SELV.

Warning! De portar som är märkta "Ethernet", "10BaseT", "Token Ring", "Console" och "AUX" är SELV-kretsar, d.v.s. skyddskretsar med extra låg spänning (SELV: safety extra-low voltage = skyddsklenspanning). SELV-kretsar får endast anslutas till andra SELV-kretsar.

ISDN Connection Warning



Warning The ISDN connection is regarded as a source of voltage that should be inaccessible to user contact. Do not attempt to tamper with or open any public telephone operator (PTO)-provided equipment or connection hardware. Any hardwired connection (other than by nonremovable, connect-one-time-only lug) must be made only by PTO staff or suitably trained engineers.

Waarschuwing De verbinding met ISDN (Integrated Services Digital Network = Digitaal netwerk met geïntegreerde faciliteiten) wordt beschouwd als een spanningsbron die ontoegankelijk dient te zijn voor gebruikers. Gebruikers dienen geen poging te doen om door de openbare telefoondienst (PTT) verstrekte apparatuur of aansluitingshardware te openen of ermee te knoeien. Alle vastbedrade verbindingen (behalve die verbindingen die gemaakt zijn door niet-verwijderbare, slechts eenmaal te verbinden aansluitpunten) dienen slechts door PTT-personeel of door daartoe opgeleide ingenieurs gemaakt te worden.

Varoitus ISDN-liitäntää pidetään jännitelähteenä, jonka kanssa käyttäjän ei tulisi päästä kosketuksiin. Käyttäjien ei tulisi yrittää peukaloida tai avata laitteita tai liittimiä, jotka kuuluvat yleiselle puhelinlaitokselle (PTO). Ainoastaan yleisen puhelinlaitoksen henkilökunnan tai ammattitaitoisten teknikoiden tulee tehdä kaapeliliitännät (lukuun ottamatta kiinteitä kiinnityskorvia, jotka yhdistetään ainoastaan yhden kerran).

Attention La connexion du réseau numérique intégré (Integrated Services Digital Network ou ISDN) constitue une source de tension qui ne doit pas être accessible à l'utilisateur. Les utilisateurs ne doivent jamais tenter de modifier ni même d'ouvrir un matériel fourni par une compagnie de téléphone public, ou le matériel de connexion. Toute connexion câblée (autre que celles établies par cosse non démontable à connexion unique) ne doit être effectuée que par le personnel de la compagnie du téléphone ou par des techniciens proprement formés.

Warnung Die ISDN-Verbindung (Integrated Services Digital Network = diensteintegrierendes Digitalnetz) gilt als eine Spannungsquelle, die dem Anwender unzugänglich sein sollte. Anwender sollten nicht versuchen, sich an der von den Anbietern öffentlicher TK-Dienste gelieferten Ausstattung oder Verbindungs-Hardware zu schaffen zu machen oder sie zu öffnen. Alle festverdrahteten Verbindungen (mit Ausnahme der mit nicht entfernbaren, einmal anzuschließenden Kabelschuhen hergestellten) sind von Mitarbeitern des TK-Anbieters oder von entsprechend ausgebildeten Technikern herzustellen.

Avvertenza Il collegamento ISDN (Integrated Services Digital Network -Rete digitale a servizi integrati) viene considerato come una fonte di tensione che dovrebbe essere inaccessibile al contatto dell'utente. Gli utenti non devono manomettere o provare ad aprire le apparecchiature o i componenti di collegamento forniti dalla società telefonica. Qualsiasi collegamento cablato (ad eccezione di un conettore non rimovibile, da installare una sola volta) deve essere eseguito esclusivamente da un dipendente della società telefonica o da tecnici specializzati.

Advarsel ISDN-koblingen betraktes som en spenningskilde som bør være utilgjengelig for brukeren. Brukere bør ikke klusse med eller åpne utstyr eller tilkoblingsmateriale som er utstyrt av Telenor. Eventuelle faste installasjoner (bortsett fra koblinger som er foretatt med kabelsko for engangsbruk og som ikke kan fjernes) må kun utføres av Telenor-montører.

Aviso A conexão RDIS (Rede Digital com Integração de Serviços) é interpretada como uma fonte de tensão que deverá ser inacessível ao utilizador. Os utilizadores não deverão tentar violar qualquer equipamento ou conexão de serviço telefónico público. Qualquer conexão de rede de fios (para além da estabelecida por terminais não-removíveis de ligação única), deverá apenas ser efectuada por pessoal dos serviços telefónicos ou engenheiros devidamente treinados.

¡Advertencia! La conexión al circuito RDSI (Red Digital de Servicios Integrados) se considera como una fuente de voltaje con la cual el usuario no debe entrar en contacto. Los usuarios deberán evitar manipular indebidamente, o abrir, los equipos o hardware de conexión proporcionados por cualquier compañía operadora de la red pública de telefonía. Las conexiones de cable rígido que sean necesarias (excepto las de lengüeta no desmontable de un solo uso) deberán ser realizadas exclusivamente por personal de la entidad operadora de la red pública de telefonía, o por personal técnico adecuadamente capacitado.

Warning! ISDN-anlutningen betraktas som en spänningskälla och bör inte vara åtkomlig för användaren (ISDN: Integrated Services Digital Network = digitalt flertjänstnät). Användare får inte manipulera eller söka öppna utrustning eller anslutningsdon som tillhandahållits av telefonbolag (PTO-produkter). Anslutning av ledningar (med undantag av icke löstagbara kabelskor för engångsanslutning) får endast utföras av PTO-anställda eller lämpligt utbildade tekniker.

Warning Statement for Norway and Sweden



Advarsel Apparatet skal kobles til en jordet stikkontakt.

Varning! Apparaten skall anslutas till jordat nätuttag.

Warning Statement for Finland



Varoitus Alleviates ja suojalukitus ohitettaessa olet alttiina näkymättömälle lasersäteilylle. Äjã katso säteeseen.

Class 1 Laser Product Warning



Warning Class 1 laser product.

Waarschuwing Klasse-1 laser produkt.

Varoitus Luokan 1 lasertuote.

Attention Produit laser de classe 1.

Warnung Laserprodukt der Klasse 1.

Avvertenza Prodotto laser di Classe 1.

Advarsel Laserprodukt av klasse 1.

Aviso Produto laser de classe 1.

¡Advertencia! Producto láser Clase I.

Varning! Laserprodukt av klass 1.

Laser Beam Warning



Warning Do not stare into the beam or view it directly with optical instruments.

Waarschuwing Niet in de straal staren of hem rechtstreeks bekijken met optische instrumenten.

Varoitus Älä katso säteeseen äläkä tarkastele sitä suoraan optisen laitteen avulla.

Attention Ne pas fixer le faisceau des yeux, ni l'observer directement à l'aide d'instruments optiques.

Warnung Nicht direkt in den Strahl blicken und ihn nicht direkt mit optischen Geräten prüfen.

Avvertenza Non fissare il raggio con gli occhi né usare strumenti ottici per osservarlo direttamente.

Advarsel Stirr eller se ikke direkte pCE strElen med optiske instrumenter.

Aviso Não olhe fixamente para o raio, nem olhe para ele directamente com instrumentos ópticos.

¡Advertencia! No mirar fijamente el haz ni observarlo directamente con instrumentos ópticos.

Varning! Rikta inte blicken in mot strålen och titta inte direkt på den genom optiska instrument.

Invisible Laser Radiation Warning



Warning Because invisible laser radiation may be emitted from the aperture of the port when no cable is connected, avoid exposure to laser radiation and do not stare into open apertures.

Waarschuwing Omdat er onzichtbare laserstraling uit de opening van de poort geëmitteerd kan worden wanneer er geen kabel aangesloten is, dient men om blootstelling aan laserstraling te vermijden niet in de open openingen te kijken.

Varoitus Kun porttiin ei ole kytketty kaapelia, portin aukosta voi vuotaa näkymätöntä lasersäteilyä. Älä katso avoimiin aukkoihin, jotta et altistu säteilylle.

Attention Etant donné qu'un rayonnement laser invisible peut être émis par l'ouverture du port quand aucun câble n'est connecté, ne pas regarder dans les ouvertures béantes afin d'éviter tout risque d'exposition au rayonnement laser.

Warnung Aus der Öffnung des Ports kann unsichtbare Laserstrahlung austreten, wenn kein Kabel angeschlossen ist. Kontakt mit Laserstrahlung vermeiden und nicht in offene Öffnungen blicken.

Avvertenza Poiché quando nessun cavo è collegato alla porta, da quest'ultima potrebbe essere emessa radiazione laser invisibile, evitare l'esposizione a tale radiazione e non fissare con gli occhi porte a cui non siano collegati cavi.

Advarsel Usynlige laserstråler kan sendes ut fra åpningen på utgangen når ingen kabel er tilkoblet. Unngå utsettelse for laserstråling og se ikke inn i åpninger som ikke er tildekket.

Aviso Evite uma exposição à radiação laser e não olhe através de aberturas expostas, porque poderá ocorrer emissão de radiação laser invisível a partir da abertura da porta, quando não estiver qualquer cabo conectado.

¡Advertencia! Cuando no esté conectado ningún cable, pueden emitirse radiaciones láser invisibles por el orificio del puerto. Evitar la exposición a radiaciones láser y no mirar fijamente los orificios abiertos.

Warning! Osynliga laserstrålar kan sändas ut från öppningen i porten när ingen kabel är ansluten. Undvik exponering för laserstrålning och titta inte in i ej täckta öppningar.

Battery Handling Warning



Warning There is the danger of explosion if the battery is replaced incorrectly. Replace the battery only with the same or equivalent type recommended by the manufacturer. Dispose of used batteries according to the manufacturer's instructions.

Waarschuwing Er is ontploffingsgevaar als de batterij verkeerd vervangen wordt. Vervang de batterij slechts met hetzelfde of een equivalent type dat door de fabrikant aanbevolen is. Gebruikte batterijen dienen overeenkomstig fabrieksvoorschriften weggeworpen te worden.

Varoitus Räjähdyksen vaara, jos akku on vaihdettu väärään akkuun. Käytä vaihtamiseen ainoastaan saman- tai vastaavantyyppistä akkua, joka on valmistajan suosittelema. Hävitä käytetyt akut valmistajan ohjeiden mukaan.

Attention Danger d'explosion si la pile n'est pas remplacée correctement. Ne la remplacer que par une pile de type semblable ou équivalent, recommandée par le fabricant. Jeter les piles usagées conformément aux instructions du fabricant.

Warnung Bei Einsetzen einer falschen Batterie besteht Explosionsgefahr. Ersetzen Sie die Batterie nur durch den gleichen oder vom Hersteller empfohlenen Batterietyp. Entsorgen Sie die benutzten Batterien nach den Anweisungen des Herstellers.

Avvertenza Pericolo di esplosione se la batteria non è installata correttamente. Sostituire solo con una di tipo uguale o equivalente, consigliata dal produttore. Eliminare le batterie usate secondo le istruzioni del produttore.

Advarsel Det kan være fare for eksplosjon hvis batteriet skiftes på feil måte. Skift kun med samme eller tilsvarende type som er anbefalt av produsenten. Kasser brukte batterier i henhold til produsentens instruksjoner.

Aviso Existe perigo de explosão se a bateria for substituída incorrectamente. Substitua a bateria por uma bateria igual ou de um tipo equivalente recomendado pelo fabricante. Destrua as baterias usadas conforme as instruções do fabricante.

¡Advertencia! Existe peligro de explosión si la batería se reemplaza de manera incorrecta. Reemplazar la batería exclusivamente con el mismo tipo o el equivalente recomendado por el fabricante. Desechar las baterías gastadas según las instrucciones del fabricante.

Warning! Explosionsfara vid felaktigt batteribyte. Ersätt endast batteriet med samma batterityp som rekommenderas av tillverkaren eller motsvarande. Följ tillverkarens anvisningar vid kassering av använda batterier.

Grounded Equipment Warning



Warning This equipment is intended to be grounded. Ensure that the host is connected to earth ground during normal use.

Waarschuwing Deze apparatuur hoort geaard te worden. Zorg dat de host-computer tijdens normaal gebruik met aarde is verbonden.

Varoitus Tämä laitteisto on tarkoitettu maadoitettavaksi. Varmista, että isäntälaitte on yhdistetty maahan normaalikäytön aikana.

Attention Cet équipement doit être relié à la terre. S'assurer que l'appareil hôte est relié à la terre lors de l'utilisation normale.

Warnung Dieses Gerät muß geerdet werden. Stellen Sie sicher, daß das Host-Gerät während des normalen Betriebs an Erde gelegt ist.

Avvertenza Questa apparecchiatura deve essere collegata a massa. Accertarsi che il dispositivo host sia collegato alla massa di terra durante il normale utilizzo.

Advarsel Dette utstyret skal jordes. Forviss deg om vertsterminalen er jordet ved normalt bruk.

Aviso Este equipamento deverá estar ligado à terra. Certifique-se que o host se encontra ligado à terra durante a sua utilização normal.

¡Advertencia! Este equipo debe conectarse a tierra. Asegurarse de que el equipo principal esté conectado a tierra durante el uso normal.

Warning! Denna utrustning är avsedd att jordas. Se till att värdenheten är jordad vid normal användning.

Product Disposal Warning



Warning Ultimate disposal of this product should be handled according to all national laws and regulations.

Waarschuwing Dit produkt dient volgens alle landelijke wetten en voorschriften te worden afgedankt.

Varoitus Tämän tuotteen lopullisesta hävittämisestä tulee huolehtia kaikkia valtakunnallisia lakeja ja säännöksiä noudattaen.

Attention La mise au rebut définitive de ce produit doit être effectuée conformément à toutes les lois et réglementations en vigueur.

Warnung Dieses Produkt muß den geltenden Gesetzen und Vorschriften entsprechend entsorgt werden.

Avvertenza L'eliminazione finale di questo prodotto deve essere eseguita osservando le normative italiane vigenti in materia.

Advarsel Endelig disponering av dette produktet må skje i henhold til nasjonale lover og forskrifter.

Aviso A descartagem final deste produto deverá ser efectuada de acordo com os regulamentos e a legislação nacional.

¡Advertencia! El desecho final de este producto debe realizarse según todas las leyes y regulaciones nacionales.

Warning! Slutlig kassering av denna produkt bör skötas i enlighet med landets alla lagar och föreskrifter.

Ground Connection Warning



Warning When installing the unit, the ground connection must always be made first and disconnected last.

Waarschuwing Bij de installatie van het toestel moet de aardverbinding altijd het eerste worden gemaakt en het laatste worden losgemaakt.

Varoitus Laitetta asennettaessa on maahan yhdistäminen aina tehtävä ensiksi ja maadoituksen irti kytkeminen viimeiseksi.

Attention Lors de l'installation de l'appareil, la mise à la terre doit toujours être connectée en premier et déconnectée en dernier.

Warnung Der Erdanschluß muß bei der Installation der Einheit immer zuerst hergestellt und zuletzt abgetrennt werden.

Avvertenza In fase di installazione dell'unità, eseguire sempre per primo il collegamento a massa e disconnetterlo per ultimo.

Advarsel Når enheten installeres, må jordledningen alltid tilkobles først og frakobles sist.

Aviso Ao instalar a unidade, a ligação à terra deverá ser sempre a primeira a ser ligada, e a última a ser desligada.

¡Advertencia! Al instalar el equipo, conectar la tierra la primera y desconectarla la última.

Warning! Vid installation av enheten måste jordledningen alltid anslutas först och kopplas bort sist.

Jewelry Removal Warning



Warning Before working on equipment that is connected to power lines, remove jewelry (including rings, necklaces, and watches). Metal objects will heat up when connected to power and ground and can cause serious burns or weld the metal object to the terminals.

Waarschuwing Alvorens aan apparatuur te werken die met elektrische leidingen is verbonden, sieraden (inclusief ringen, kettingen en horloges) verwijderen. Metalen voorwerpen worden warm wanneer ze met stroom en aarde zijn verbonden, en kunnen ernstige brandwonden veroorzaken of het metalen voorwerp aan de aansluitklemmen lassen.

Varoitus Ennen kuin työskentelet voimavirtajohtoihin kytkettyjen laitteiden parissa, ota pois kaikki korut (sormukset, kaulakorut ja kellot mukaan lukien). Metalliesineet kuumenevat, kun ne ovat yhteydessä sähkövirran ja maan kanssa, ja ne voivat aiheuttaa vakavia palovammoja tai hitsata metalliesineet kiinni liitäntänapoihin.

Attention Avant d'accéder à cet équipement connecté aux lignes électriques, ôter tout bijou (anneaux, colliers et montres compris). Lorsqu'ils sont branchés à l'alimentation et reliés à la terre, les objets métalliques chauffent, ce qui peut provoquer des blessures graves ou souder l'objet métallique aux bornes.

Warnung Vor der Arbeit an Geräten, die an das Netz angeschlossen sind, jeglichen Schmuck (einschließlich Ringe, Ketten und Uhren) abnehmen. Metallgegenstände erhitzen sich, wenn sie an das Netz und die Erde angeschlossen werden, und können schwere Verbrennungen verursachen oder an die Anschlußklemmen angeschweißt werden.

Avvertenza Prima di intervenire su apparecchiature collegate alle linee di alimentazione, togliersi qualsiasi monile (inclusi anelli, collane, braccialetti ed orologi). Gli oggetti metallici si riscaldano quando sono collegati tra punti di alimentazione e massa: possono causare ustioni gravi oppure il metallo può saldarsi ai terminali.

Advarsel Fjern alle smykker (inkludert ringer, halskjeder og klokker) før du skal arbeide på utstyr som er koblet til kraftledninger. Metallgjenstander som er koblet til kraftledninger og jord blir svært varme og kan forårsake alvorlige brannskader eller smelte fast til polene.

Aviso Antes de trabalhar em equipamento que esteja ligado a linhas de corrente, retire todas as jóias que estiver a usar (incluindo anéis, fios e relógios). Os objectos metálicos aquecerão em contacto com a corrente e em contacto com a ligação à terra, podendo causar queimaduras graves ou ficarem soldados aos terminais.

¡Advertencia! Antes de operar sobre equipos conectados a líneas de alimentación, quitarse las joyas (incluidos anillos, collares y relojes). Los objetos de metal se calientan cuando se conectan a la alimentación y a tierra, lo que puede ocasionar quemaduras graves o que los objetos metálicos queden soldados a los bornes.

Warning! Tag av alla smycken (inklusive ringar, halsband och armbandsur) innan du arbetar på utrustning som är kopplad till kraftledningar. Metallobjekt hettas upp när de kopplas ihop med ström och jord och kan förorsaka allvarliga brännskador; metallobjekt kan också sammansvetsas med kontaktarna.

Chassis Lifting Warning



Warning Two people are required to lift the chassis. Grasp the chassis underneath the lower edge and lift with both hands. To prevent injury, keep your back straight and lift with your legs, not your back. To prevent damage to the chassis and components, never attempt to lift the chassis with the handles on the power supplies or on the interface processors, or by the plastic panels on the front of the chassis. These handles were not designed to support the weight of the chassis.

Waarschuwing Er zijn twee mensen nodig om het frame op te tillen. Het frame dient onder de onderste rand vastgegrepen en met beide handen omhooggetild te worden. Om te voorkomen dat u letsel oploopt, dient u uw rug recht te houden en met behulp van uw benen, niet uw rug, te tillen. Om schade aan het frame en de onderdelen te voorkomen, mag u nooit proberen om het frame op te tillen aan de handvatten op de voedingen of op de interface-processors of aan de kunststof panelen aan de voorkant van het frame. Deze handvatten zijn niet ontworpen om het gewicht van het frame te dragen.

Varoitus Asennuspohjan nostamiseen tarvitaan kaksi henkilöä. Ota ote asennuspohjan alareunasta ja nosta molemmin käsin. Pitäen selkäsi suorana nosta jalkojen (ei selän) avulla, jotta välttäisit loukkaantumista. Älä yritä nostaa asennuspohjaa virtalähteen tai liitäntäprossessorin kahvoista tai asennuspohjan etuosan muovipaneeleista, jotta estät asennuspohjan ja rakenneosien vaurioitumisen. Näitä kahvoja ei ole suunniteltu kestämään asennuspohjan painoa.

Attention Il faut deux personnes pour soulever le châssis. Le saisir par son rebord inférieur et soulever des deux mains. Pour éviter tout trauma de la région lombaire, garder le dos droit et soulever la charge en redressant les jambes. Pour éviter d'endommager le châssis et ses composants, ne jamais tenter de le soulever par les poignées des blocs d'alimentation ou des processeurs d'interface, ni par les panneaux en plastique à l'avant du châssis. Ces poignées ne sont pas prévues pour supporter le poids du châssis.

Warnung Zum Anheben des Chassis werden zwei Personen benötigt. Fassen Sie das Chassis unterhalb der unteren Kante an und heben es mit beiden Händen an. Um Verletzungen zu vermeiden, ist der Rücken aufrecht zu halten und das Gewicht mit den Beinen, nicht mit dem Rücken, anzuheben. Um Schäden an Chassis und Bauteilen zu vermeiden, heben Sie das Chassis nie an den Kunststoffabdeckungen vorne am Chassis oder mit den Griffen am Netzgerät oder an den Schnittstellenprozessoren an. Diese Griffe sind nicht so konstruiert, daß sie das Gewicht des Chassis tragen könnten.

Avvertenza Il telaio va sollevato da due persone. Afferrare il telaio al di sotto del bordo inferiore e sollevare con entrambe le mani. Per evitare infortuni, mantenere la schiena diritta e sollevare il peso con le gambe, non con la schiena. Per evitare danni al telaio ed ai componenti, non provare mai a sollevare il telaio tramite le maniglie sugli alimentatori o sui processori di interfaccia oppure tramite i pannelli in plastica sulla parte anteriore del telaio. Queste maniglie non sono state progettate per sostenere il peso del telaio.

Advarsel Det er nødvendig med to personer for å løfte kabinettet. Ta tak i kabinettet under den nedre kanten, og løft med begge hender. Unngå personskade ved å holde ryggen rett og løfte med bena, ikke ryggen. Unngå skade på kabinettet og komponentene ved å aldri prøve å løfte kabinettet etter håndtakene på strømforsyningsenhetene, grensesnittprosessorene eller i plastpanelene foran på kabinettet. Disse håndtakene er ikke beregnet på å tåle vekten av kabinettet.

Aviso São necessárias duas pessoas para levantar o chassis. Agarre o chassis imediatamente abaixo da margem inferior, e levante-o com ambas as mãos. Para evitar lesões, mantenha as suas costas direitas e levante o peso com ambas as pernas, sem forçar as costas. Para prevenir danos no chassis e nos seus componentes, nunca tente levantá-lo pelas asas das unidades abastecedoras de energia, nem pelos processadores de interface, ou pelos painéis plásticos localizados na frente do chassis. Estas asas não foram criadas para suportar o peso do chassis.

¡Advertencia! Se necesitan dos personas para levantar el chasis. Sujete el chasis con las dos manos por debajo del borde inferior y levántelo. Para evitar lesiones, mantenga la espalda recta y levántelo con la fuerza de las piernas y no de la espalda. Para evitar daños al chasis y a sus componentes, no intente nunca levantar el chasis por las asas de las fuentes de alimentación o de los procesadores de interfase, ni por los paneles de plástico situados en el frontal del chasis. Las asas no han sido diseñadas para soportar el peso del chasis.

Warning! Det krävs två personer för att lyfta chassit. Fatta tag i chassit under den nedre kanten och lyft med båda händerna. För att undvika skador skall du hålla ryggen rak och lyfta med benen, inte ryggen. Chassit och delarna kan skadas om du försöker lyfta chassit i handtagen på strömförsörjningsenheterna eller gränssnittsprocessorerna, eller i plastpanelerna på chassits framsida. Handtagen är inte konstruerade för att hålla chassits tyngd.

Lifting the Chassis by the Handles Warning



Warning *Never* attempt to lift the chassis with the handles on the power supplies or the switching modules. These handles are not designed to support the weight of the chassis. Using them to lift or support the chassis can result in severe damage to the equipment and serious bodily injury.

Waarschuwing Het chassis mag *nooit* door middel van de hendels aan de voedingsbronnen of schakelapparaten opgetild worden. Deze hendels zijn niet bedoeld om het gewicht van het chassis te kunnen dragen. Als de hendels gebruikt worden om het chassis op te tillen of te ondersteunen, kan dit grote beschadiging van de apparatuur en ernstig lichamelijk letsel veroorzaken.

Varoitus Älä yritä *milloinkaan* nostaa asennuspohjaa virtalähteiden tai kytkentämoduulien kahvoista. Näitä kahvoja ei ole suunniteltu kestämään asennuspohjan painoa. Niiden käyttö asennuspohjan nostamiseen tai kannattamiseen voi johtaa vakavaan laitevaurioon ja vakavaan ruumiinvammaan.

Avertissement N'essayez *jamais* de lever le châssis à l'aide des poignées du module d'alimentation ou de commutation. Ces poignées ne sont pas conçues pour résister à de fortes charges. Les utiliser pour lever le châssis risque de provoquer des dommages importants à l'appareil et des blessures corporelles graves.

Achtung Das Gehäuse niemals an den Griffen der Stromversorgungs- oder der Schaltmodule anheben. Diese Griffe können das Gehäusegewicht nicht tragen. Wenn sie zum Anheben oder Stützen des Gehäuses benutzt werden, besteht Gefahr schwerer Geräteschäden und Personenverletzungen.

Avvertenza *Non* tentare *mai* di sollevare lo chassis utilizzando i manici degli alimentatori o dei moduli di commutazione. Questi manici non sono stati progettati per sostenere il peso dello chassis. Se utilizzati per sollevare o sostenere lo chassis può causare gravi lesioni e danni all'apparecchio.

Advarsel Forsøk *aldri* å løfte kabinettet ved hjelp av håndtakene på strømforsyningsenhetene eller omkoblingsmodulene. Disse håndtakene er ikke konstruert for å tåle vekten av kabinettet. Ved å bruke disse til å løfte eller støtte opp kabinettet, kan du forårsake alvorlig skade på mennesker og utstyr.

Aviso *Nunca* tente levantar o chassis pelas asas das unidades de fornecimento de energia ou dos módulos de comutação. Estas asas não foram criadas para suportar o peso do chassis. A sua utilização para este efeito, poderá resultar em danos extensos no equipamento e em ferimentos graves.

¡Atención! No intentar nunca levantar el chasis por las asas de las fuentes de alimentación o de los módulos de conmutación. Las asas no han sido diseñadas para soportar el peso del chasis. Si se usan para levantar o sostener el chasis pueden producirse serios daños a los equipos y lesiones físicas graves.

Varning Försök *inte* lyfta chassit i handtagen på strömförsörjningsaggregaten eller väljarmodulerna. Dessa handtag är inte konstruerade för chassits vikt. Om de används för att lyfta eller stödja chassit kan allvarliga materiella skador samt kroppsskador uppstå.

Cisco Connection Online

Cisco Connection Online (CCO) is Cisco Systems' primary, real-time support channel. Maintenance customers and partners can self-register on CCO to obtain additional information and services.

Available 24 hours a day, 7 days a week, CCO provides a wealth of standard and value-added services to Cisco's customers and business partners. CCO services include product information, product documentation, software updates, release notes, technical tips, the Bug Navigator, configuration notes, brochures, descriptions of service offerings, and download access to public and authorized files.

CCO serves a wide variety of users through two interfaces that are updated and enhanced simultaneously: a character-based version and a multimedia version that resides on the World Wide Web (WWW). The character-based CCO supports Zmodem, Kermit, Xmodem, FTP, and Internet e-mail, and it is excellent for quick access to information over lower bandwidths. The WWW version of CCO provides richly formatted documents with photographs, figures, graphics, and video, as well as hyperlinks to related information.

You can access CCO in the following ways:

- WWW: <http://www.cisco.com>
- WWW: <http://www-europe.cisco.com>
- WWW: <http://www-china.cisco.com>
- Telnet: cco.cisco.com
- Modem: From North America, 408 526-8070; from Europe, 33 1 64 46 40 82. Use the following terminal settings: VT100 emulation; databits: 8; parity: none; stop bits: 1; and connection rates up to 28.8 kbps.

For a copy of CCO's Frequently Asked Questions (FAQ), contact cco-help@cisco.com. For additional information, contact cco-team@cisco.com.

Note If you are a network administrator and need personal technical assistance with a Cisco product that is under warranty or covered by a maintenance contract, contact Cisco's Technical Assistance Center (TAC) at 800 553-2447, 408 526-7209, or tac@cisco.com. To obtain general information about Cisco Systems, Cisco products, or upgrades, contact 800 553-6387, 408 526-7208, or cs-rep@cisco.com.

Documentation CD-ROM

Cisco documentation and additional literature are available in a CD-ROM package, which ships with your product. The Documentation CD-ROM, a member of the Cisco Connection Family, is updated monthly. Therefore, it might be more current than printed documentation. To order additional copies of the Documentation CD-ROM, contact your local sales representative or call customer service. The CD-ROM package is available as a single package or as an annual subscription. You can also access Cisco documentation on the World Wide Web at <http://www.cisco.com>, <http://www-china.cisco.com>, or <http://www-europe.cisco.com>.

If you are reading Cisco product documentation on the World Wide Web, you can submit comments electronically. Click **Feedback** in the toolbar and select **Documentation**. After you complete the form, click **Submit** to send it to Cisco. We appreciate your comments.

This document is to be used in conjunction with the *Cisco 7000 Hardware Installation and Maintenance* manual and the *Cisco 7000 Hardware Installation and Maintenance* manual, and with the documentation that shipped with the Cisco products described in this document.

Access Registrar, AccessPath, Any to Any, AtmDirector, CCDA, CCDE, CCDP, CCIE, CCNA, CCNP, CCSI, CD-PAC, the Cisco logo, Cisco Certified Internetwork Expert logo, CiscoLink, the Cisco Management Connection logo, the Cisco NetWorks logo, the Cisco Powered Network logo, Cisco Systems Capital, the Cisco Systems Capital logo, Cisco Systems Networking Academy, the Cisco Technologies logo, ControlStream, Fast Step, FireRunner, GigaStack, IGX, JumpStart, Kernel Proxy, MGX, Natural Network Viewer, NetSonar, Network Registrar, Packet, PIX, Point and Click Internetworking, Policy Builder, Precept, RouteStream, Secure Script, ServiceWay, SlideCast, SMARTnet, StreamView, *The Cell*, TrafficDirector, TransPath, ViewRunner, VirtualStream, VisionWay, VlanDirector, Workgroup Director, and Workgroup Stack are trademarks; Changing the Way We Work, Live, Play, and Learn, Empowering the Internet Generation, The Internet Economy, and The New Internet Economy are service marks; and Asist, BPX, Catalyst, Cisco, Cisco IOS, the Cisco IOS logo, Cisco Systems, the Cisco Systems logo, the Cisco Systems Cisco Press logo, Enterprise/Solver, EtherChannel, EtherSwitch, FastHub, FastLink, FastPAD, FastSwitch, IOS, IP/TV, IPX, LightStream, LightSwitch, MICA, NetRanger, Registrar, StrataView Plus, Stratum, TeleRouter, and VCO are registered trademarks of Cisco Systems, Inc. in the U.S. and certain other countries. All other trademarks mentioned in this document are the property of their respective owners. (9904R)

Copyright © 1993–1999, Cisco Systems, Inc.
All rights reserved.